

APPLICATION NOTES

S20

FOR THE



FM / AM-1500

**COMMUNICATIONS SERVICE
MONITOR**

**PUBLISHED BY
IFR SYSTEMS, INC.
WICHITA, KS 67215**

Copyright ©1986 by IFR SYSTEMS, INC.

All rights reserved. Printed in the United States of America. No part of this publication may be reproduced, stored in a retrieval system or transmitted in any form or by any means, electronic, mechanical, photocopying, recording or otherwise without prior permission of the publisher.

**Manual Part Number: 1002-5001-500
Original Printing: July 1986**

TABLE OF CONTENTS

	INTRODUCTION		
page			
4-5	HOW TO USE THIS BOOK		
	RECEIVER MEASUREMENTS		
page			
6-7	Check local oscillators & xtals without opening radio case		
8-9	Measuring audio frequency response with tone sweep		
10-11	Measuring 12 dB SINAD, Receiver Center Frequency and Modulation Acceptance Bandwidth		
12-13	Checking IF Bandwidth & Symmetry		
14-17	Receiver RF filter alignment		
18-19	High accuracy FM deviation measurements using the Bessel null technique		
	TRANSMITTER MEASUREMENTS		
page			
20-21	Measuring the output of very low power transmitters		
22-25	Measuring transmitter harmonics		
26-27	Stage gain measurements using the spectrum analyzer		
28-29	Analyzing receiver desense due to external transmitter intermodulation		
			TRANSMITTER MEASUREMENTS continued
		page	
		30-31	Measuring isolation and insertion loss in Tx-Rx switches
		32-33	Monitoring SSB & ACSB testing
		34-35	Synchronizing Simulcast Transmitters
			ANTENNA & TRANSMISSION LINE MEASUREMENTS
		page	
		36-37	Measuring Antenna Isolation
		38-41	Tuning Antennas for Minimum VSWR
		42-43	Cable Fault Location and Finding Cable Stub Lengths
			DUPLEXER MEASUREMENTS
		page	
		44-45	Measuring Center Frequency, Insertion Loss and 3dB Points on Cavities
		46-47	Transmitter cavity alignment
		48-49	Bandpass / Band reject duplexer alignment
		50-51	Measuring receiver desense in a duplexed system
		52-53	Measuring receiver isolation at Tx & Rx frequencies
		54-55	Measuring Tx noise suppression at Rx frequency

HOW TO USE THIS BOOK

← Application **TITLE** box

This Application Note book contains actual field applications of the IFR FM/AM-1500 Communications Service Monitor.

Overview... highlights of application ↓

DETAILS

Comments

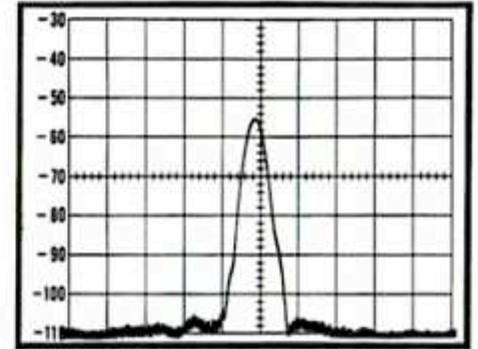

CRT IMAGES & WAVEFORMS

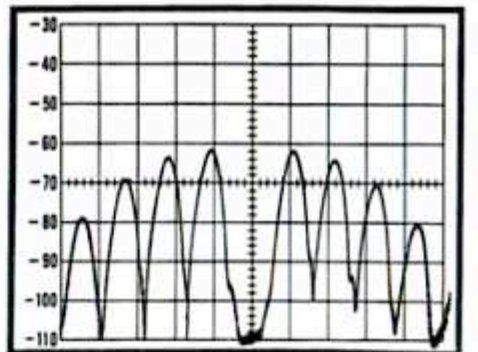
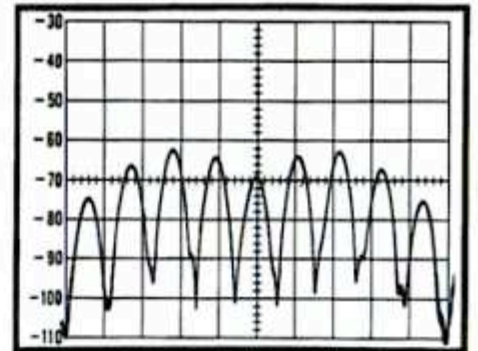

DETAILED SETUP

IFR FM/AM-1500

XMTR or RCVR in FREQUENCY window indicates that you select proper frequency for the equipment under test.

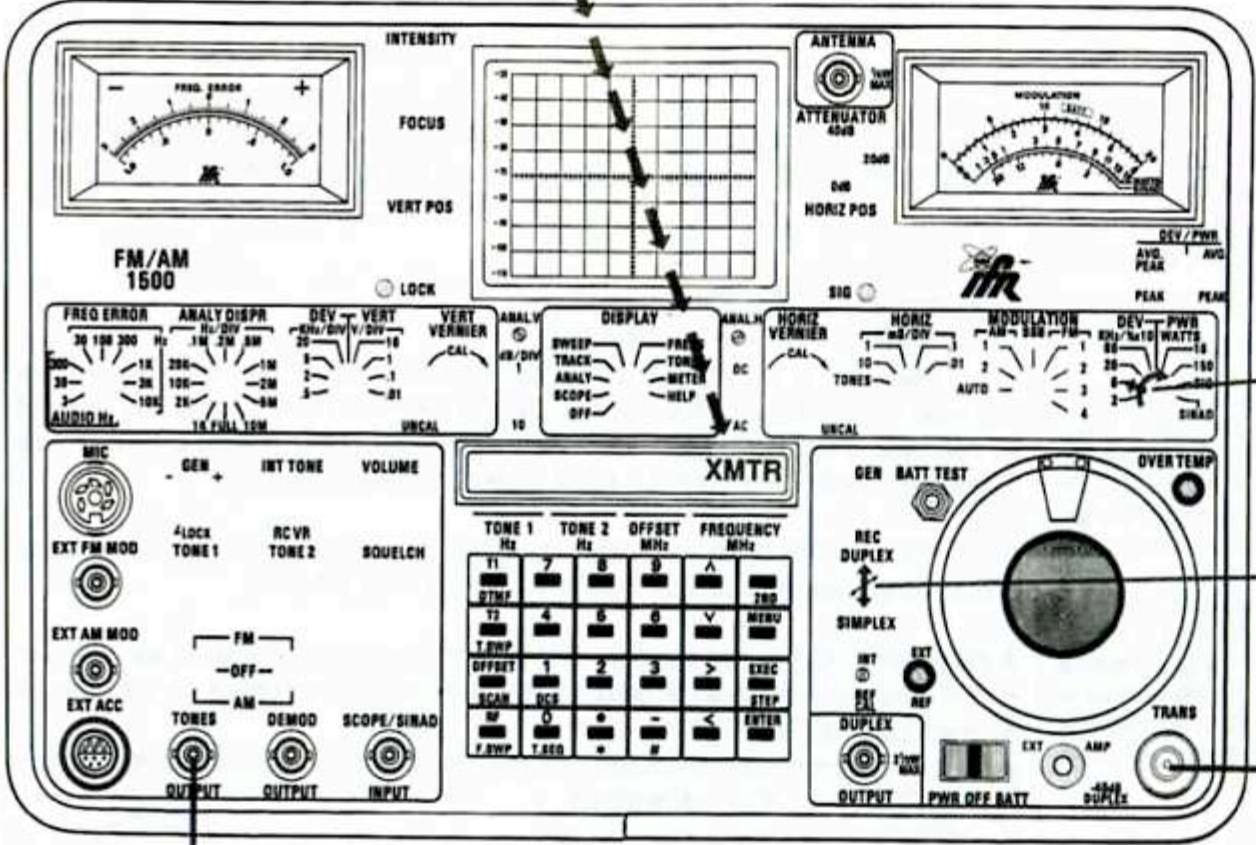

HOW TO USE THIS BOOK

This facing page shows connection information and the position of pertinent controls.

Those controls, readouts or indicators shown in BLUE affect the operation in this particular application.

SYMBOL EXPLANATION

Denotes a control requiring adjustment during the application.

Denotes a switch requiring a change of position during the application.



APPLICATION NOTE

Check local oscillators & xtals without opening radio case

CONCEPT

There is nothing fancy or complicated about an inductive pickup. The concept is to connect the high sensitivity spectrum analyzer ($2 \mu\text{v}$) to an antenna that only picks up a small percentage of signal, obviously you don't want to look at all of the signals that are present in your shop. A 2 turn pickup loop works well from about 100 kHz through VHF. With the spectrum analyzer set to one of the wider dispersion settings, you can quickly determine the operation of the local oscillators.

EXAMPLE

Suppose that a hand-held VHF radio operating at 150 MHz comes across your bench. You know from experience that it probably has a first IF on or near 10.7 MHz. If you set the analyzer center **FREQUENCY** at 150.0000 MHz and the **ANALYZER DISPERSION** to 5 MHz per horizontal division, the analyzer will scan from 125 to 175 MHz. Most radios radiate enough to pick up the high frequency local oscillator easily with the **SNIFFER LOOP** anywhere close to the radio. The Hi Freq L.O. should show up about two divisions to the left or right of the center frequency of 150 MHz. Exact frequency of any signal you can see on the analyzer is easily measured by joggling the **FREQUENCY** until the unknown signal is within 10 KHz, then use the error meter to get an exact reading.

Checking the Lo Freq local oscillator would be just as easy by setting the **FREQUENCY** of the analyzer on 10.7 MHz and **ANALY DISP** to .2M. Now the analyzer will sweep from 9.7 to 11.7 MHz. The Lo Freq oscillator would typically be about 2.25 divisions (455 kHz) above or below center. The **SNIFFER LOOP** is less sensitive at the lower frequencies and the Lo Freq oscillator coil is usually shielded better than HF coils so you may have to hunt around the case a little to find the signal.

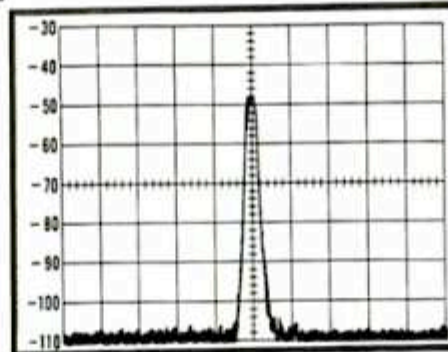

Local oscillator picked up with sniffer loop

A **SNIFFER LOOP** lets you use the high sensitivity of the spectrum analyzer to show you if the local oscillators are running without opening the case.

If you haven't used a **SNIFFER LOOP** we suggest you build yourself two of them and keep them with your 1500. One is used for **SNIFFING**, the second one is useful for non-contact signal injection. You may want to **COLOR CODE** both ends with vinyl tape to keep track of which one is injecting and which one is receiving.

A **SNIFFER LOOP** is such a useful tool when attached to your spectrum analyzer and tracking generator that you'll wonder how you've done without it.

A **SNIFFER LOOP** is nothing more than one or two turns of insulated wire on one end of a convenient length of coax. Install a male BNC connector on the other to connect to the 1500's **ANTENNA** input.

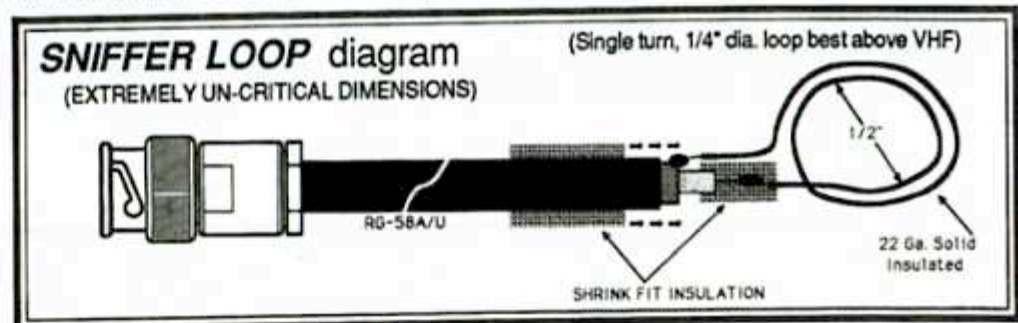

DETAILED SETUP

IFR FM/AM-1500

Connect **SNIFFER LOOP** to **ANTENNA** port

ATTENUATOR switch must be in 0 dB position for maximum sensitivity.

SNIFFER LOOP use

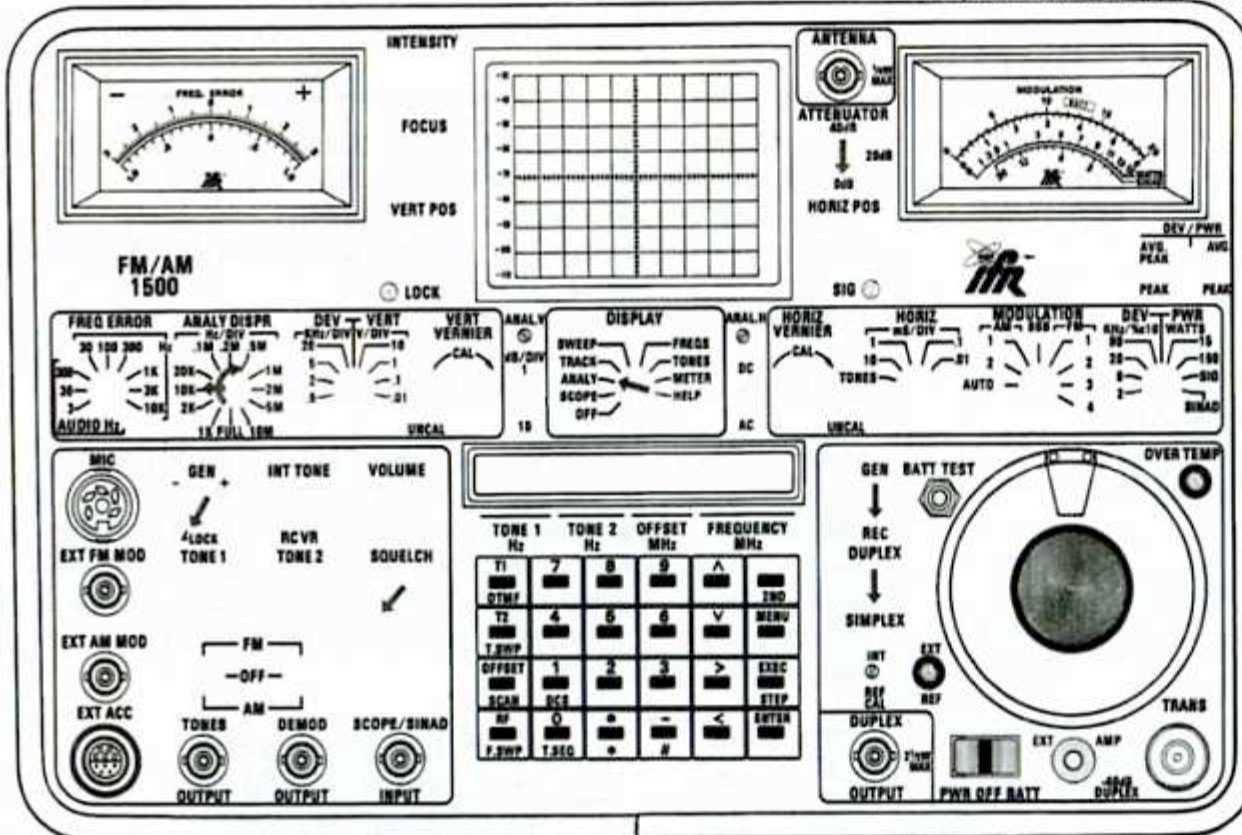

**Check local oscillators & xtals
without opening radio case**

Couple loop to the radiating coil to get at least a -80dBm response on the analyzer screen. -80dBm will quiet the FM/AM-1500's receiver section sufficiently to get a good **FREQ ERROR** reading once you have centered the signal near the center of the screen at an **ANALY DISPR** setting of *less* than 10K.

REMEMBER.. you are dealing with 2 receivers in the 1500, the spectrum analyzer and the monitor receiver. Both use the same front end and connect to the outside world via the **ANTENNA** port.

CAUTION: When using the **SNIFFER LOOP** on transmitters, bring the loop towards the radio *after keying*. Don't couple closely *until* you see the signal on the analyzer to avoid overloading or possible front end burn out. Keep the signal on the analyzer screen below the top (-30dBm) to prevent spurious generation due to overloading.

DETAILED SETUP

IFR FM/AM-1500

Connect **SNIFFER LOOP** to **ANTENNA** port

ATTENUATOR switch must be in 0 dB position for maximum sensitivity.

SNIFFER LOOP use

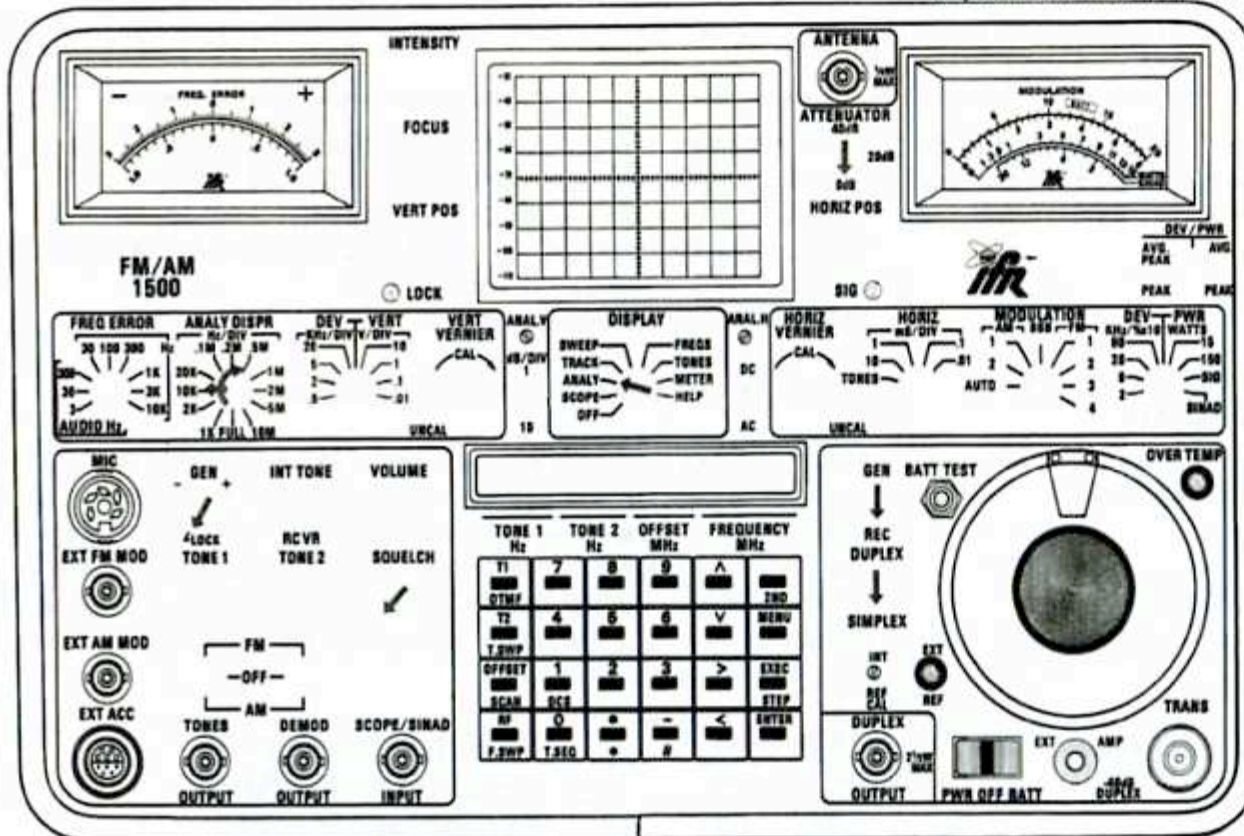

Check local oscillators & xtals without opening radio case

Couple loop to the radiating coil to get at least a -80dBm response on the analyzer screen. -80dBm will quiet the FM/AM-1500's receiver section sufficiently to get a good **FREQ ERROR** reading once you have centered the signal near the center of the screen at an **ANALY DISPR** setting of *less* than 10K.

REMEMBER.. you are dealing with 2 receivers in the 1500, the spectrum analyzer and the monitor receiver. Both use the same front end and connect to the outside world via the **ANTENNA** port.

CAUTION: When using the **SNIFFER LOOP** on transmitters, bring the loop towards the radio *after keying*. Don't couple closely *until* you see the signal on the analyzer to avoid overloading or possible front end burn out. Keep the signal on the analyzer screen below the top (-30dBm) to prevent spurious generation due to overloading.

Measuring audio frequency response with tone sweep

The 1500's Tone sweep menu can simplify audio frequency response testing by stepping through the 300-3000 Hz range quickly in octave steps so that receiver de-emphasis or transmitter pre-emphasis response may be checked.

If we set the audio output at 300 Hz to fill the 8 vertical divisions of the scope, then each octave increase in frequency should be half as many divisions if the receiver audio output meets the standard 6dB per octave de-emphasis curve.

PROCEDURE

Set DISPLAY to TONES Key ENTER, MENU, Δ , Δ , this should bring up the TONE SWEEP MENU on the CRT.

Key ENTER, 4, \blacktriangleright , the cursor will now flash under START FREQ. Set the frequency to 300.

\blacktriangleright will move the cursor to STOP FREQ. Set it at 3000.

\blacktriangleright , moves the cursor on to INCRemental STEP. Key the Δ until it reads X.

In the next position enter the factor 2.0, this indicates that at each step the frequency will be doubled (an octave).

Set the INCRemental RATE to 5000 msec.

To start the TONE SWEEP running, use the following sequence.

ENTER, EXECUTE, 2ND, T.SWP, 4, \bullet (loop), ENTER.

TONE generator 1 will begin automatically stepping every 5 seconds through the following frequencies: 300, 600, 1200, 2400, 3000 Hz. The loop (\bullet) repeats the function. Neat, but not real handy unless you have a plotter for the output. Even with a plotter you would still have to take the 6dB per octave decrease into account.

Now, How do I stop the darn thing?

2nd, STEP will halt the cycle and leave the tone on.

Now, Δ will step the frequency up an octave at a time.(300 to 2400) If you step to 300 Hz and use the VERT VERNIER to fill the scope with the 300 Hz sine wave, each stroke of the Δ key will double the frequency which should cut the audio amplitude in half if it fits the de-emphasis curve. The top step to 3000 Hz gives you a final check at the top of the audio passband to check for excessive roll off even though it isn't an octave step.

300 Hz = 8 div.
600 Hz = 4 div.
1200 Hz = 2 div.
2400 Hz = 1 div.
3000 Hz = 0.8 div.

Peak to peak levels required to conform to 6dB per octave de-emphasis curve

Once programmed, this function will remain in the TONE SWEEP MENU as ITEM #04 for future use. (We selected item 4 so it won't be changed as easily when you call up the menu)

DETAILED SETUP

IFR FM/AM-1500

Measuring audio frequency response with tone sweep

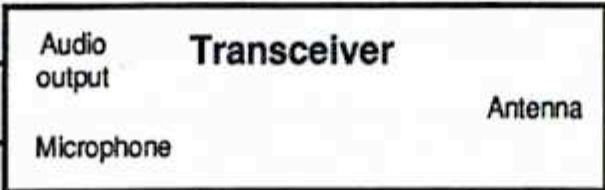
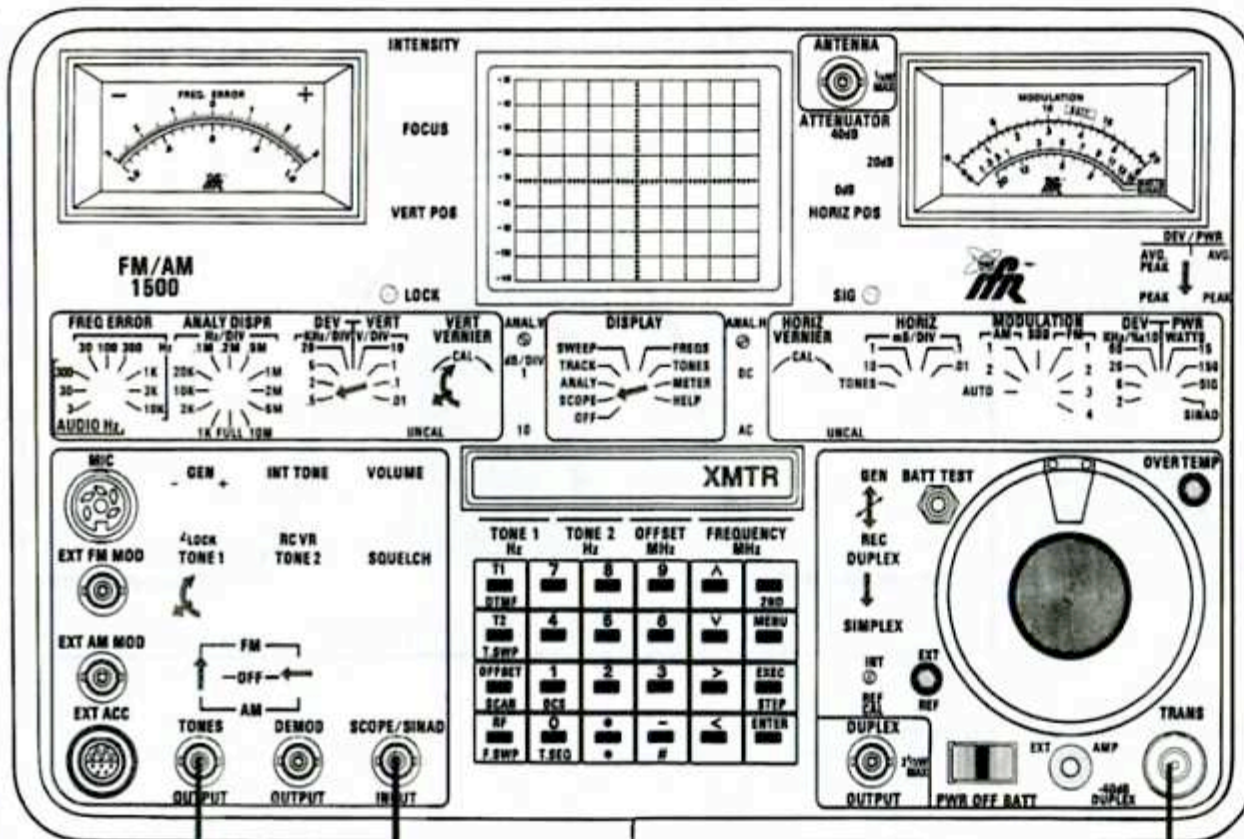

RECEIVER RESPONSE

The setup shown is for measuring receiver audio response as described on the facing page.

TRANSMITTER RESPONSE

Transmitter audio response may be measured by modulating the transmitter with **TONES OUTPUT** and measuring the deviation on the scope in the .5 KHz/DIV position.

Set the modulation level of the transmitter with the **TONE 1** level control to produce 8 divisions of deflection on CRT at 2400 Hz.

Each octave step down in frequency should produce half the amplitude of audio if the pre-emphasis circuit is operating properly.

Measuring 12dB SINAD Sensitivity, Receiver Center Frequency and Modulation Acceptance Bandwidth

Measurement of MODULATION ACCEPTANCE BANDWIDTH while set up to do the normal 12dB SINAD SENSITIVITY test will quickly determine the radio's overall low level signal performance. The RECEIVER CENTER FREQUENCY test will tell you if the local oscillators are close to their design frequency and if the IF is aligned properly.

The 12dB SINAD SENSITIVITY, RECEIVER CENTER FREQUENCY and MODULATION ACCEPTANCE BANDWIDTH all contribute to a receiver's performance at low signal levels.

SINAD SENSITIVITY

SINAD is the acronym for **Signal + Noise And Distortion**. SINAD is the voltage ratio of signal, noise and distortion to noise and distortion and is expressed in dB. 12dB is the most common SINAD specification point. SINAD is a more accurate method of measuring the *readability* of a signal because it measures distortion in the 1 kHz signal in addition to quieting. A badly distorted audio signal will fail a SINAD test.

RECEIVER CENTER FREQUENCY

The receiver center frequency is the frequency that produces the best SINAD reading.

MODULATION ACCEPTANCE BANDWIDTH

Modulation acceptance bandwidth is measured by increasing the deviation until distortion occurs in the 1 kHz tone due to bandwidth limitations.

APPLICATION NOTE

RECEIVER RESPONSE CURVE

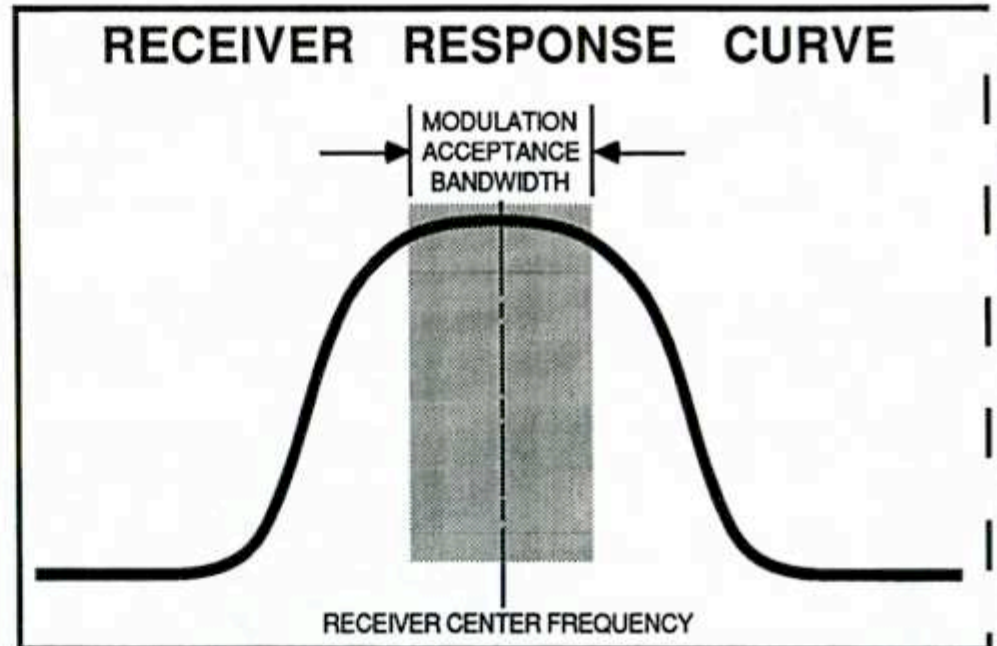

NOTES _____

DETAILED SETUP

IFR FM/AM-1500

Measuring 12dB SINAD Sensitivity, Receiver Center Frequency and Modulation Acceptance Bandwidth

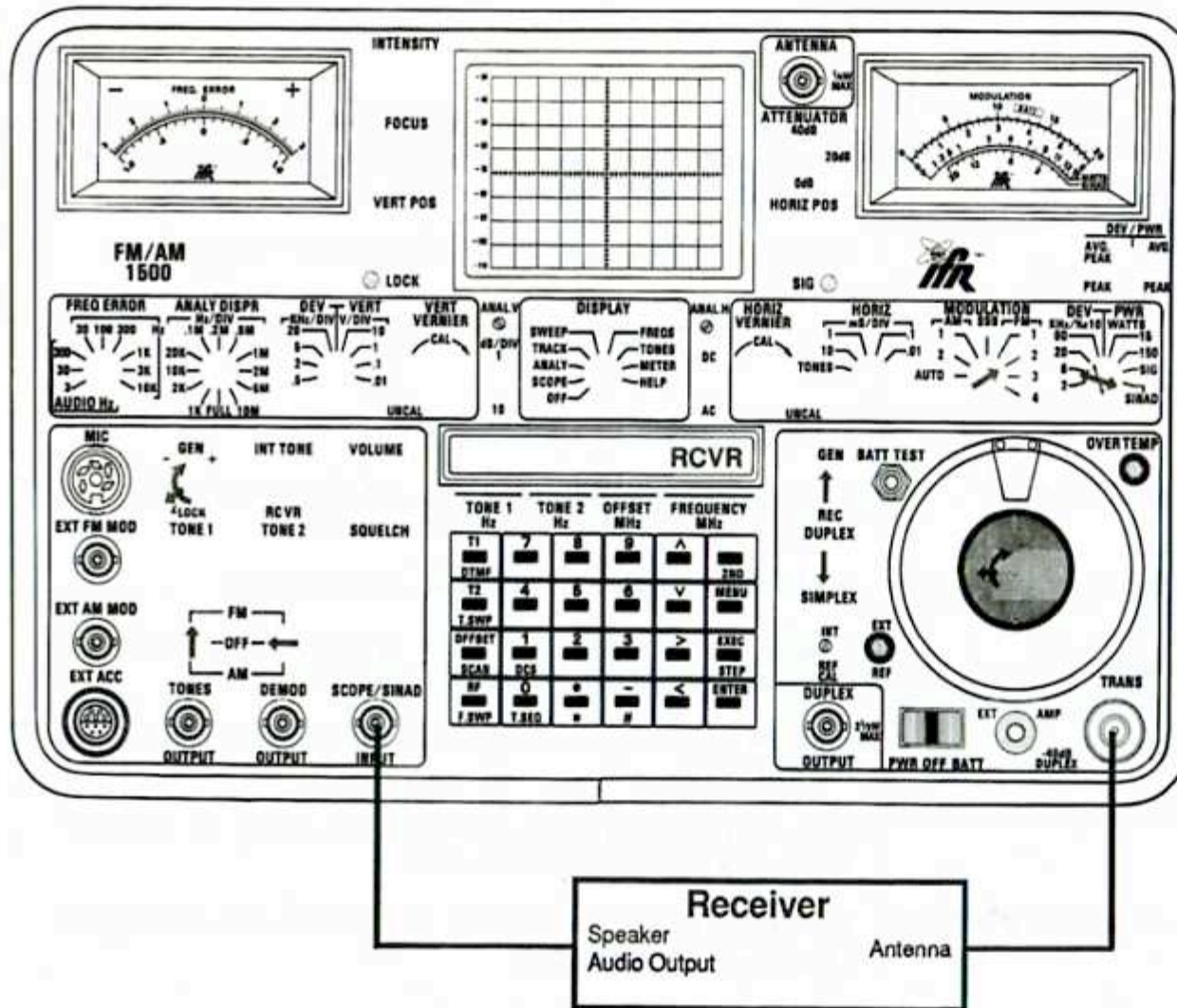

SINAD SENSITIVITY and RECEIVER CENTER FREQUENCY

(MAKE SURE TONE 1 IS 1000 Hz NOT 10MHz!)
 After setting T1 to 1000.0 Hz and adjusting TONE 1 level to 3 kHz of deviation, switch DEV PWR to SINAD. *ADJUST W/ "TONE 2" CTRL. UNSQUELCH RCVR!*

Increase RF output from minimum until needle on SINAD meter reads about 12dB.

NOTE - USE HIGH AUDIO LEVEL TO GET SOLID RESPONSE
 Advance the GEN control clockwise from the LOCK position to get the highest SINAD reading possible. That is the RECEIVER CENTER FREQUENCY, leave the GEN control at that position.

Readjust the RF level to get 12dB SINAD, reading the RF dial at the cursor to determine SINAD SENSITIVITY.

MODULATION ACCEPTANCE BANDWIDTH

With controls in the same position as above, increase the RF level 6dB. The SINAD reading will increase due to the stronger signal.

Increase deviation with the TONE 1 control until SINAD returns to 12dB as the distortion increases due to bandwidth limitations. The deviation as read on the MODULATION meter is the MODULATION ACCEPTANCE BANDWIDTH. Normal readings are in the 6-9 kHz range.

Checking Receiver I.F. Bandwidth and Symmetry

The I.F. filtering network determines the receiver's selectivity. If it is too narrow, audio distortion will be produced. If it is too wide, there is apt to be adjacent channel interference. Symmetry of the I.F. filter is important for recovering audio with the lowest distortion.

TO MEASURE I.F. BANDWIDTH (60dB skirt width)

Open the squelch fully on the receiver under test.

Set the 1500's **FREQUENCY** to the receiver frequency.

Set **TONE 1** frequency to 1000.0 Hz.

Set **DEV / PWR** to 2 KHz.

Set **TONE 1** level to produce 1KHz deviation on **MODULATION** meter.
Reset **DEV / PWR** to **SINAD**.

Adjust RF output to achieve a 12dB **SINAD** reading.

Note the dBm reading on the RF output dial, that's your **REFERENCE SENSITIVITY**. (typical example: -110dBm)

Raise RF output to 60 dB above **REF. SENS.** (example: -50dBm)

Move the cursor in the **FREQUENCY** window to the last position on the right, the hundred hertz position.

Jog the frequency up in hundred hertz steps with the **^** key until the **SINAD** meter again reads 12dB. Note the upper frequency.

Jog the frequency down with the **v** key through center and to the point on the low side where 12dB **SINAD** is again achieved.

APPLICATION NOTE

Distortion should begin at approximately the same \pm frequency offsets.

The difference between the high and low **SINAD** points is the 60 dB "skirt width".

By listening to the receiver's audio you can hear the distortion and loss of the recovered 1kHz tone. The tone should be gone at ± 15 kHz on narrow band FM radios, indicating good adjacent channel rejection.

Distortion should begin at approximately the same \pm frequency offsets.

TO MEASURE I.F. SYMMETRY

I.F. symmetry is good if the 1 kHz audio starts breaking up at the same frequency offset either side of the center frequency.

Reset the **FREQUENCY** to the receiver's center frequency.

Advance the frequency to full offset by rotating the **GEN** control clockwise just past the detent. (out of the **LOCK** position)

Reset the squelch on the receiver under test to squelch the audio (just below threshold).

While monitoring the **FREQ. ERROR** meter, swing the frequency either side of center with the **GEN** control.

The receiver should break squelch at about the same \pm frequency offsets if the I.F. is symmetrical.

DETAILED SETUP

IFR FM/AM-1500

Checking Receiver I.F. Bandwidth and Symmetry

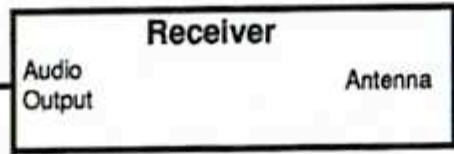
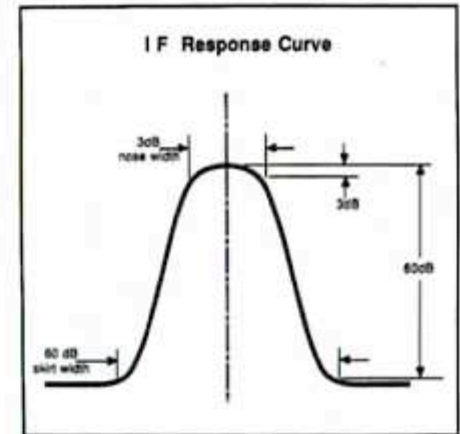
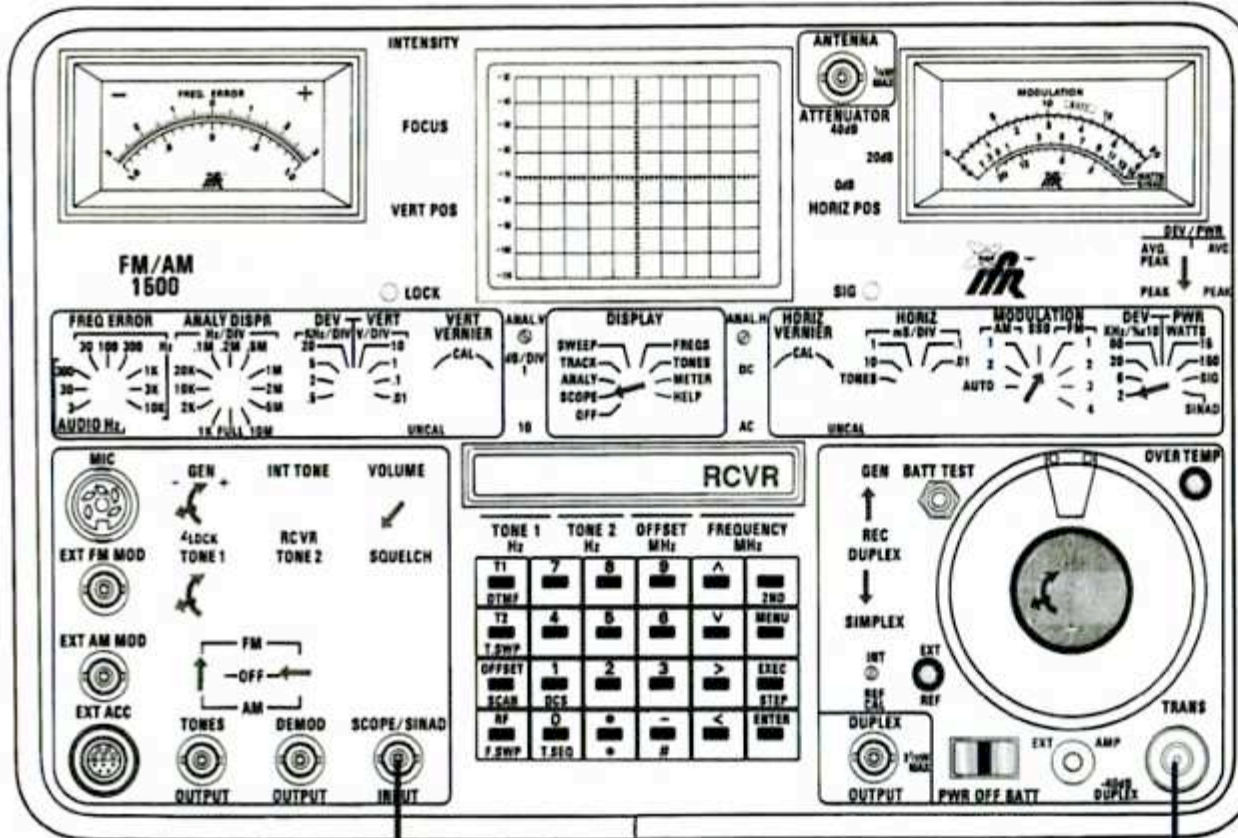

Receiver RF filter alignment

RF alignment using the tracking generator as a source and the analyzer as an indicator can provide an insight into tuning flaws that are otherwise invisible.

Inside is a case history of how the tracking generator was used to isolate a bad part, the problem that an unavoidable part substitution caused and how it was resolved.

THE SAD STORY

A dual diversity wireless microphone receiver came into the shop with one channel essentially dead.

By using a SNIFFER LOOP with the tracking generator, a bad RF FET was found quickly. It was replaced with the radio manufacturer's *substitute* part. (the original FET was no longer manufactured)

After the FET replacement, the tuning just didn't act right, it was too broad and didn't want to peak-up properly.

THE PLOT THICKENS

Feeding the tracking generator directly into the front end and using the sniffer loop to sniff the RF output coil, the analyzer showed a double hump response. The output coil resonance was too high in frequency when the slug was centered in the coil, indicating that more capacity was necessary to tune it.

After adding a small capacitor across the RF output coil, the output increased as expected as the resonance approached the receive frequency. Resonance was still too high so some more "C" was added.

RF STAGE REGENERATIVE?

As the output coil was tuned toward the receive frequency, the shape of the peak got sharper, an indication that there was regeneration. The stage was about to take-off into self-oscillation.

RF STAGE TAKES OFF

As the output stage reached resonance at the receive frequency, it went into sustained oscillation. All of this was the result of replacing a FET in the RF stage with a substitute. (Remember, the original part was no longer manufactured) The new FET had considerable more gain and had to be degenerated by raising the drain resistance.

HAPPY ENDING (you don't think we'd tell you a sad one do you?)

Once the gain was reduced, both coils could be peaked at the receiver frequency, providing a good RF response curve with stable gain. The regeneration would have been impossible to see without an analyzer. Just peaking for maximum signal wasn't enough to provide proper operation.

A single turn sniffer loop was found to be easier to use in this application at 33 MHz than an RF probe because it could be left in position over each coil form during the tuning process and didn't require an extra hand to hold it in place as the RF probe did.

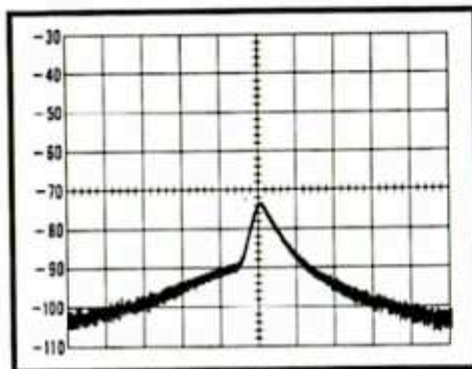

Sniffer loop on RF *input* coil as a reference.
 200 μ v fed into radio antenna jack.
DISPLAY: TRACK
ANALY DISPR: 1MHz / DIV
10 dB/DIV
FREQUENCY: 33.4 MHz

29.4 33.4 38.4 MHz

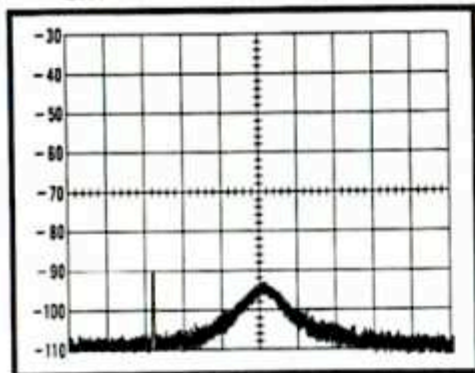

Sniffer loop on RF *output* coil.
 Obvious loss of gain.

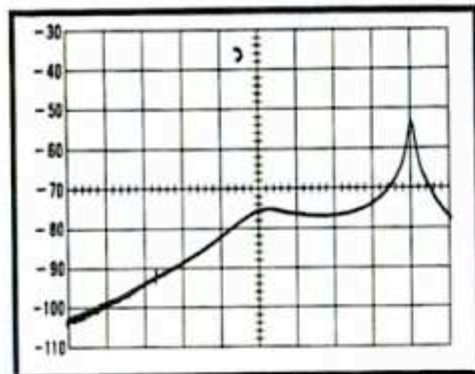

Replaced RF FET with substitute.
 Sniffer loop still on RF output coil.
 Left hump is RF input coil response.
 Right hump is RF output coil response. Output coil tuning slug at maximum inductance in middle of coil.
 Output coil resonance 4 MHz too high.

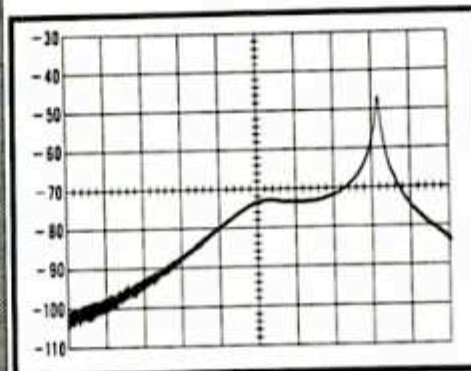

Sniffer loop still on RF output coil.
 Added small "C" to output coil to lower resonant frequency.
 Output coil resonance closer to 33.4 but peak gets sharper. Why??
 Suspect regeneration.

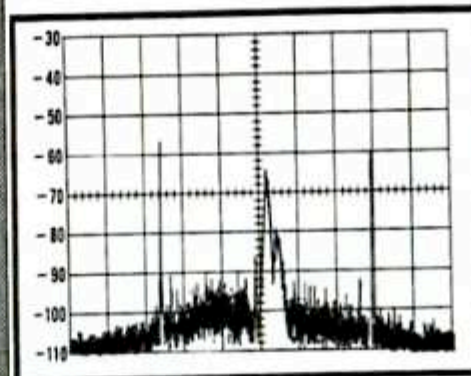

Sniffer loop still on output coil.
 More "C" is added to output coil to tune it.
 RF stage goes into sustained oscillation.

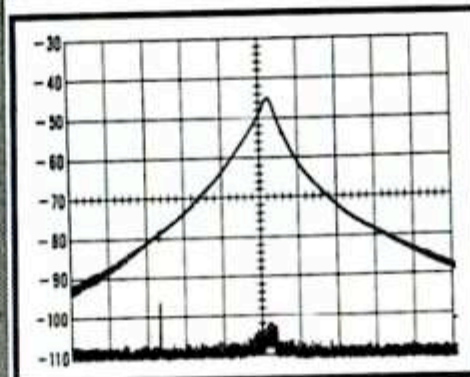

Sniffer loop still on output coil.
 FET degenerated with higher drain resistance.
 Double exposure photo:
 Top trace = RF output coil with 200 μ v into antenna.
 Bottom trace = RF output coil with no signal input.
 Slight noise hump shows amplifier stable with some normal noise amplification.

DETAILED SETUP

IFR FM/AM-1500

Receiver RF filter alignment

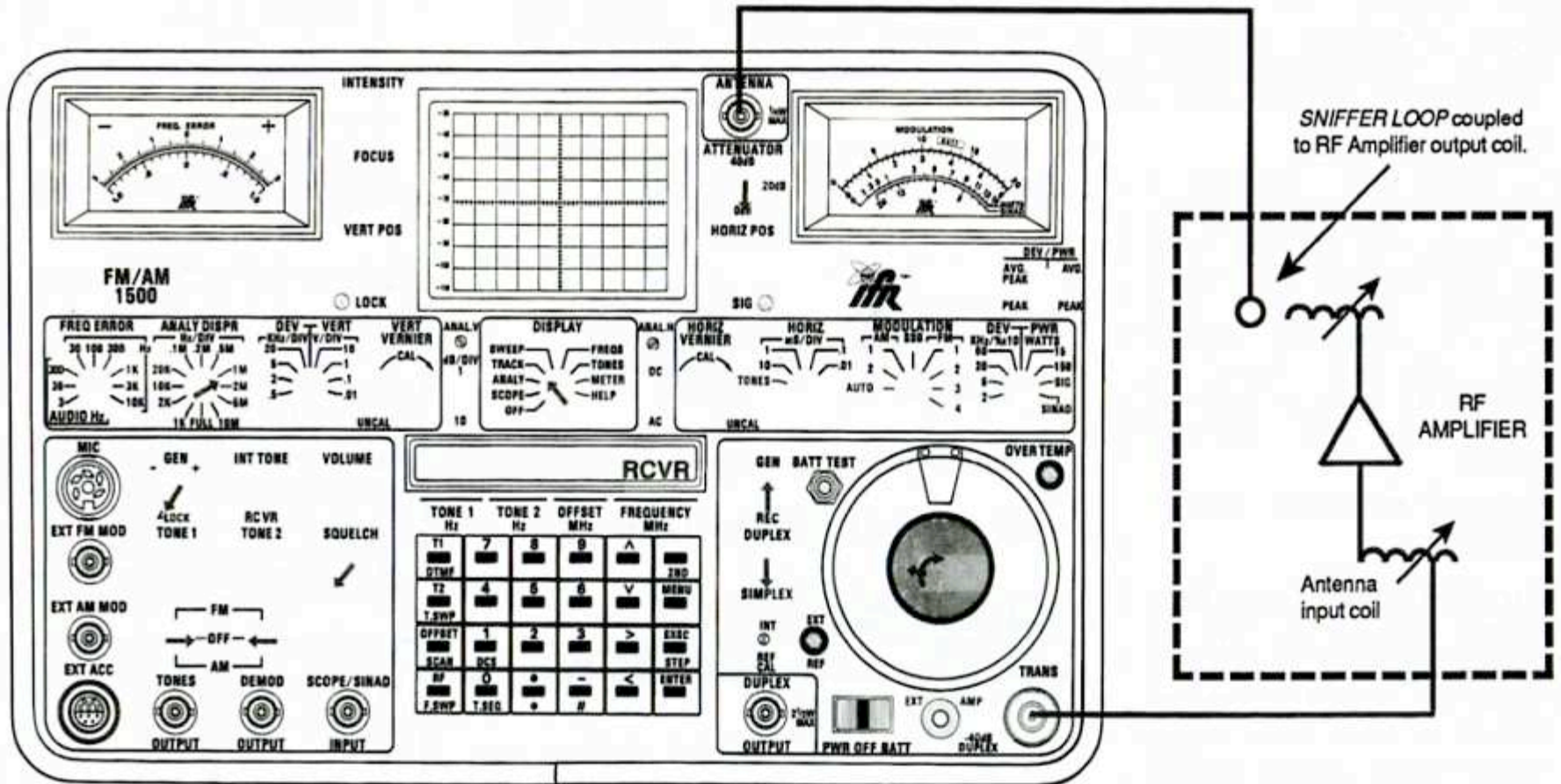

APPLICATION NOTE

High accuracy FM deviation measurements using the Bessel null technique.

Very accurate FM deviation measurements are possible using the narrow dispersion capability of the 1500's Spectrum Analyzer to determine the Bessel function null.

WHY??

The Bessel null technique is useful to determine accurately the deviation of any FM device that you can feed an accurate frequency modulating tone into... a transmitter, another signal generator, even the 1500's signal generator may be checked for FM deviation accuracy.

HOW??

Set controls as shown. Program RF to transmitter frequency so that the analyzer is centered on transmitter freq. Program T1 Modulating Frequency based on the results of the Desired Deviation formula. Increase TONE 1 level from zero until first null appears. Crosscheck on analog MODULATION meter or on digital readout by switching DISPLAY to METER.

The first null will occur when the deviation is 2.4048 times the modulating frequency.

$$\frac{\text{Desired Deviation}}{2.4048} = \text{Modulating Frequency (required to produce first null)}$$

Example: Desired Deviation = 5 kHz

$$\frac{5000 \text{ Hz Deviation}}{2.4048} = 2079.2 \text{ Hz Modulating freq.}$$

Caution:

Some transmitters' deviation limiters are fooled when they are set up with a continuous sine wave signal. Recheck peak deviation by viewing DEVIATION on SCOPE with speech input.

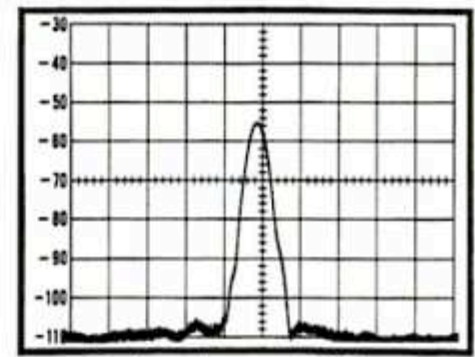

Carrier with no modulation

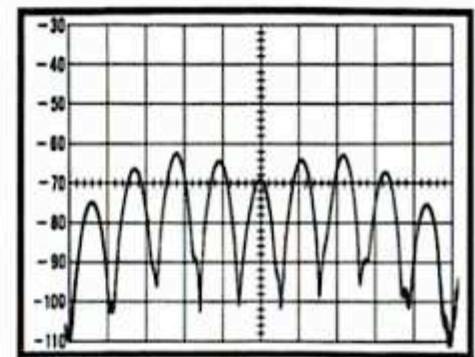

First null begins to appear at 3 kHz

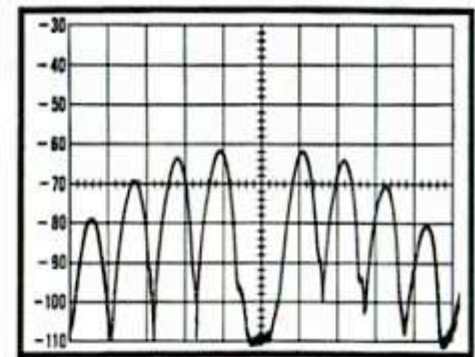

Deep null appears at exactly 5 kHz

DETAILED SETUP

IFR FM/AM-1500

High accuracy FM deviation measurements using the Bessel null technique.

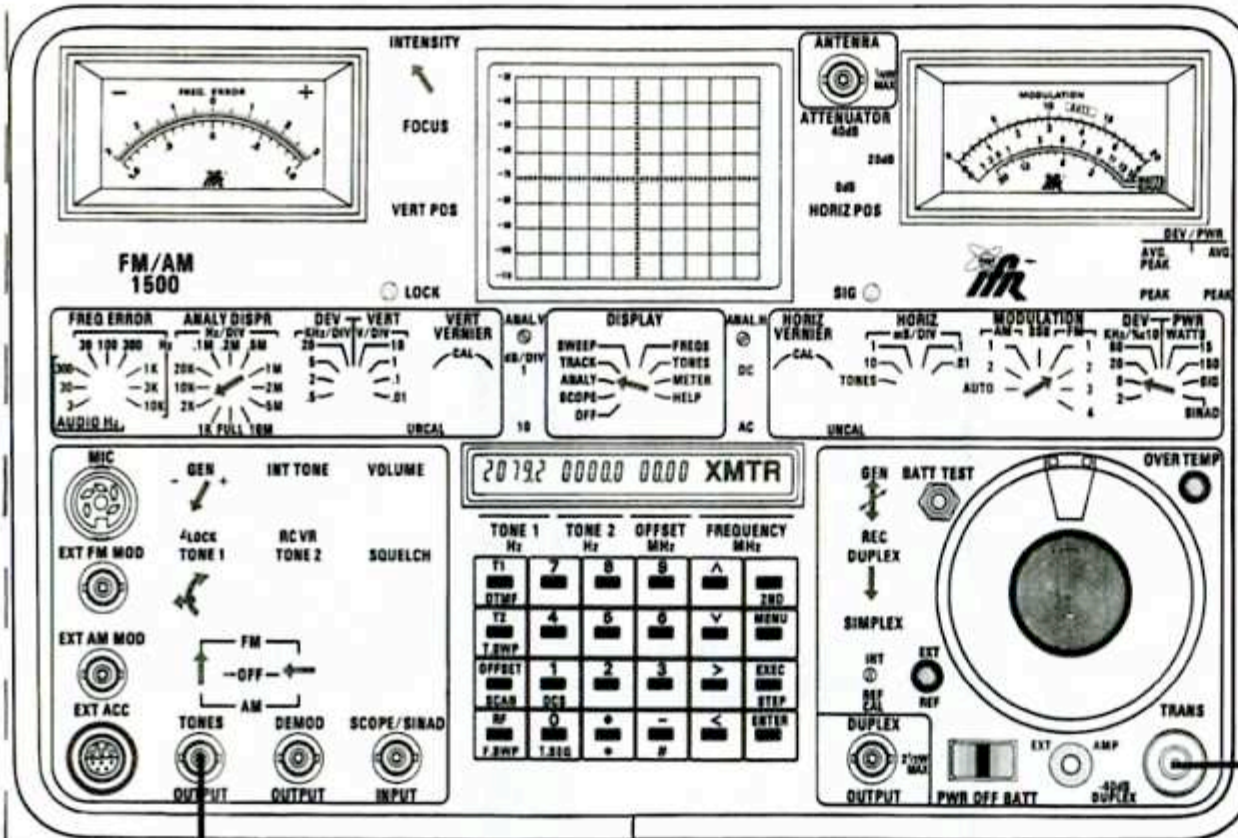

Direct connection

Connect the TONES OUTPUT to the microphone input of the transmitter.

Optional acoustical coupling to microphone

Acoustical coupling provides non-invasive testing of the transmitter by holding the microphone up to the 1500's speaker (on right side of case). Feed the 1500's tone generator to the speaker by switching to INT TONE. Speaker output level is controlled by the TONE 1 and VOLUME controls.

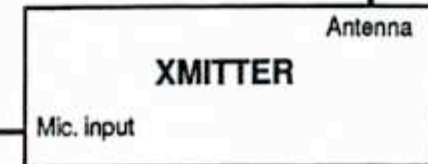

APPLICATION NOTE

Measuring the output of very low power transmitters

Wireless microphones and low power telemetry transmitters are a challenge when it comes to measuring their RF output power.

The calibrated spectrum analyzer **ANTENNA** input provides the sensitivity required to make accurate low level power measurements.

The **FREQUENCY** must be set to the transmitter output frequency so you can see the signal centered on the analyzer display.

TWEAKING NOTE:

When you are trying to peak up a low power transmitter with the analyzer display, the logarithmic response *compresses* any change, making it difficult to see small changes in amplitude. Switch the **dB/DIV** switch to the **1dB** position and re-center the top of the signal with the **VERT POS** control. In this 1dB per division mode, you can see small changes much better.

CONVERSION TABLE
dBm to WATTS

+50 dBm = 100 watts	-10 dBm = 100 μ w
+40 dBm = 10 watts	-20 dBm = 10 μ w
+30 dBm = 1 watt	-30 dBm = 1 μ w
+20 dBm = 100 milliwatts	-40 dBm = 100 nw
+10 dBm = 10 mw	-50 dBm = 10 nw
0 dBm = 1 mw	-60 dBm = 1 nw

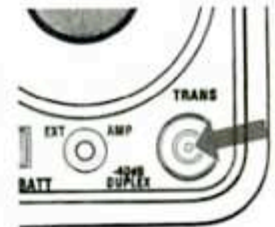
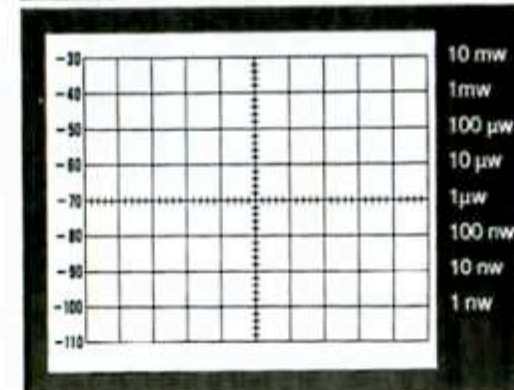
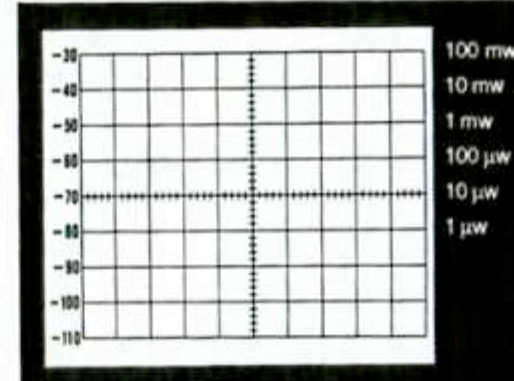
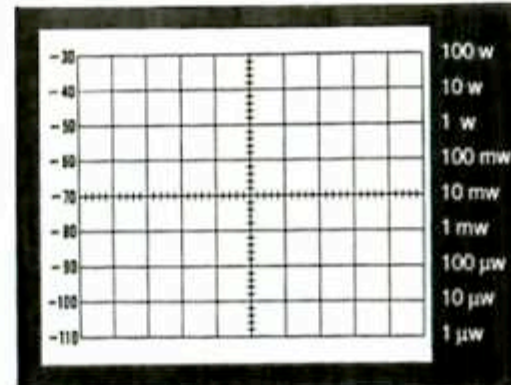

100 mw - 100 watts = Feed direct into **TRANS**mit port. (80dB path to analyzer switched in by power detector)

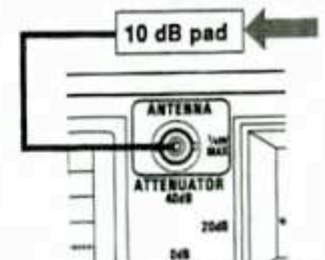

10 mw - 100 mw = Use 10dB external attenuator into **ANTENNA**. Switch in 40dB internal **ATTENUATOR**.

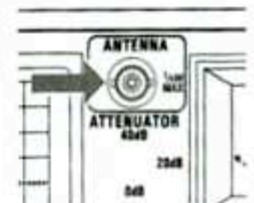

Less than 10 mw = Feed direct into **ANTENNA** port. Switch in 40dB internal **ATTENUATOR**.

DETAILED SETUP

IFR FM/AM-1500

Measuring the output of very low power transmitters

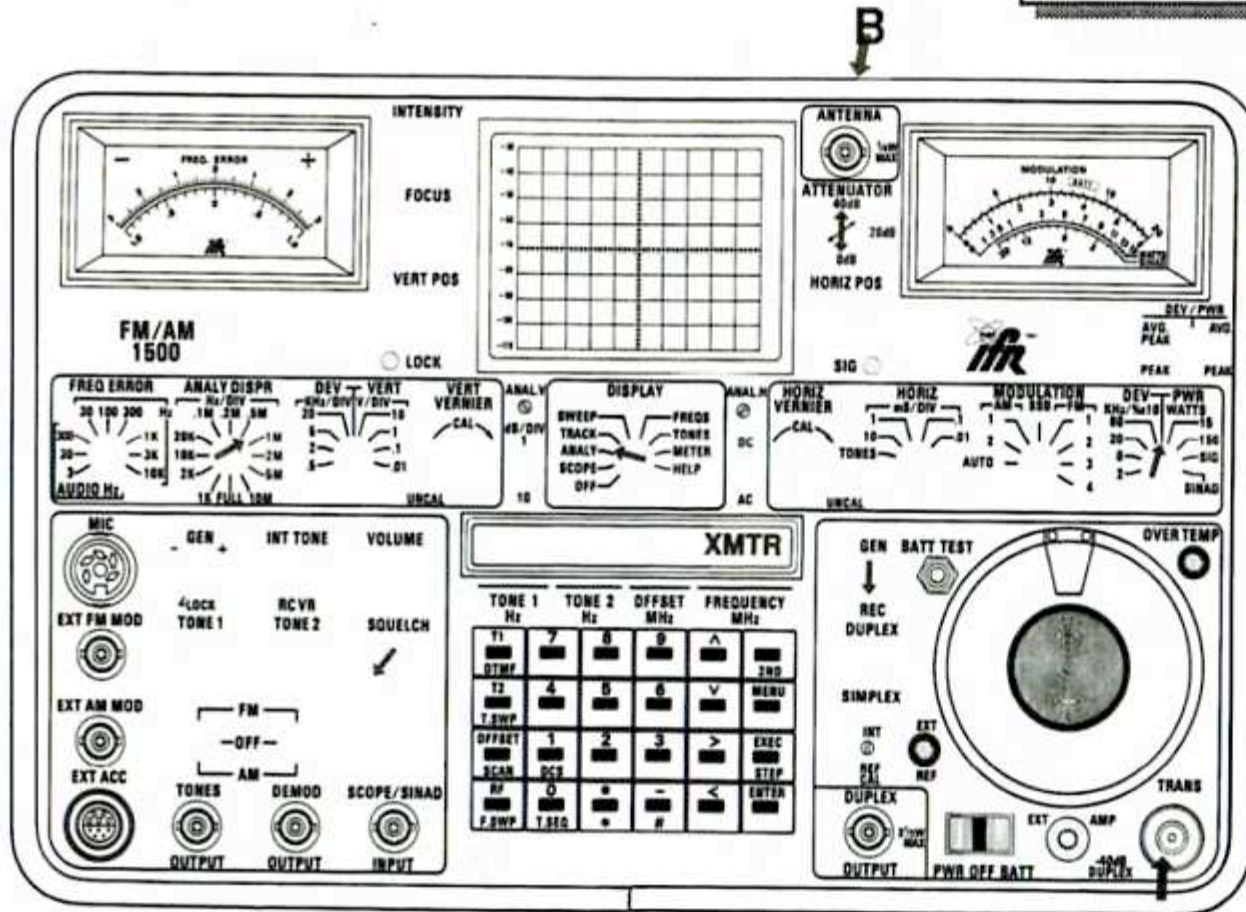

PROCEDURE:

A: Connect ANY transmitter to the TRANS jack first.. Set the DEV / PWR switch to 15 watt position. Key the transmitter and confirm that the power is **LESS THAN 1/4 watt**. (This step is important to guarantee that you don't smoke the front end by injecting more than a quarter watt into the ANTENNA jack. This quick check could save you many \$\$\$ in non-warranty repair charges.)

B: If the transmitter power is at least 100 milliwatts, the 1500 will detect it and switch in a -80dB internal path to the spectrum analyzer. The spectrum analyzer can then be used as a power indicator with the top (-30) graticule line indicating 100 watts. (See top scope photo on facing page for power correlation.)

How to cross check spectrum analyzer sensitivity:

The 1500's DUPLEX output may be used to check the sensitivity of the analyzer. Connect the DUPLEX OUTPUT to the ANTENNA port. Set GEN / REC to GEN. Set DUPLEX / SIMPLEX to DUPLEX. (this disconnects the internal signal crossfeed from the generator)

Set OFFSET to 00.00.

Using the RF output dial as a dBm reference, the top of the signal shown on the analyzer display should read the same.

Measuring transmitter harmonics

The spectrum analyzer is useful for measuring harmonic outputs. A quick check of harmonic output is easily accomplished on transmitters in the 0.2 to 100 watt range by keying them directly into the **TRANS** port as described on the facing page.

For those instances outside the 200 milliwatt - 100 watt range or where more dynamic range is required, the range expanding techniques inside this fold-out should be used.

Procedure for wider dynamic range measurements:

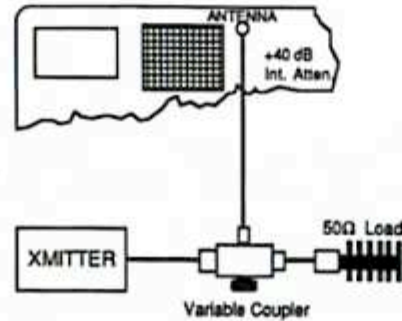

1. Connect as shown. With the **ATTENUATOR** switch in the 20 dB position, key the transmitter to view the signal at the transmitter frequency. Adjust coupler to get a full scale signal on the display. If you can't get the signal down to the top line, switch to 40 dB. Additional pads in the coupler to antenna line may be necessary depending on the loss of the coupler and the transmitter power. It is important that the transmitter fundamental level be as near the top of the screen as possible *without* exceeding it to obtain the maximum dynamic range. The internal **ATTENUATOR** needs to be in either the 20 or 40 dB position with the fundamental signal at the top graticule line. The **ATTENUATOR** switch will be switched back to 0 dB to extend the dynamic range once the high pass filter is installed.

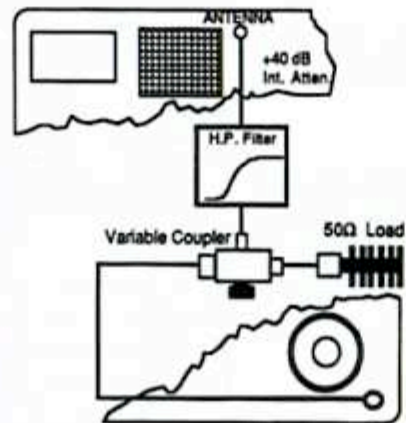

2. Measure combined loss of coupler, high pass filter, & Attenuator at F_1 .

Install the high pass filter. Disconnect the coax from the transmitter and reconnect it to the 1500's **TRANS** jack. Switch the **DISPLAY** to **TRACK**. Increase the RF output level to center the fuzzy trace on the -90 dBm line at center screen. Subtract the black dial dBm reading from -90 dBm. The difference is the loss at F_1 .

3. Measure coupler, HP filter, & Attenuator loss at F_2 .

Change the analyzer center frequency to the second harmonic (F_2) and readjust level to center the trace at -90 dBm. Subtract dial reading from -90 to determine the loss at F_2 . Now you have calibrated your measurement system at the fundamental and second harmonic.

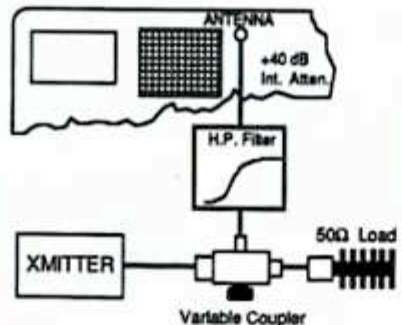

4. Measure harmonic output of transmitter.

Reconnect the coupler coax to the transmitter. Key transmitter, reading display to determine the level of the harmonic. The attenuation of the high pass filter and the coupler *at the harmonic frequency* must be added algebraically to the result to accurately reflect the harmonic level.

Measuring transmitter harmonics

VERY LOW & HIGH POWER SITUATIONS

Transmitters with output power above 100 watts will require the use of a coupler² to prevent overloading the analyzer. Transmitters with outputs below 100 milliwatts will *not* switch in the 80dB path and will require a coupler or external attenuator to reduce their output to -30dBm or below so that it can be coupled directly into the **ANTENNA** port without overloading. A variable coupler is desirable so you can adjust the coupled level to the top of the analyzer screen and utilize all of the analyzer's dynamic range.

ANALYZER DYNAMIC RANGE

The 1500's spectrum analyzer has a usable dynamic range of 70dB, from -30 (top of screen) down to -100dBm. Below -100, signals become noisy enough to make measurements more difficult.

EXPANDING ANALYZER DYNAMIC RANGE

To measure signal levels beyond the 70dB dynamic range of the analyzer, a notch filter or high pass filter¹ must be used to cut the transmitter fundamental so it doesn't overload the analyzer front end. Signals above the top of the screen (-30 dBm) will overload the 1st mixer and cause spurious signals (intermodulation products) to be generated in the analyzer. These intermod "spurs" clutter the display with extra signals, often causing great confusion and heartburn.

SPURIOUS?

To quickly determine if the signal you are looking at is a spurious generated within the analyzer ...

1. Switch in the **20dB ATTENUATOR**. If the signal level drops *more than* 20dB, it is a "spur". The amount of the drop depends on the "order" of the intermodulation product.
2. Center the signal on a major vertical graticule mark by jogging the frequency up with the ^ key. After noting that frequency, jog the frequency to the *next* major vertical line. The difference in frequency should be the setting of the **DISPR** knob. If the signal moves *more* than the knob setting, it is a "spur". If you have several signals on the analyzer display, watch the *distance* each one moves as you jog the frequency. Those that move faster than others are high order "spurs".

APPLICATION NOTE

FCC Requirements

For land mobile services at power levels below 1,000 watts, the F.C.C. harmonic specification requires that all emissions beyond 250% of the authorized bandwidth be attenuated by $43+10(\text{Log}_{10} \text{ output power in watts})\text{dB}$.

Minimum attenuation for signals
≥250% of authorized bandwidth.
(harmonics & spurious)

Transmitter power in watts	Minimum attenuation, dB below carrier	Transmitter power in watts	Minimum attenuation, dB below carrier
1	43	100	63
5	50	150	65
10	53	200	66
25	57	250	67
50	60	300	68
75	62	500	70

¹High pass filter source:
Mini-Circuits, P.O. Box 166,
Brooklyn, NY 11235, (718) 934-4500
BNC-BNC connectors, price \$27.95 ea. (June '86)
30-54 MHz transmitters = BHP-100
144-174 MHz transmitters = BHP-300
450-470 MHz transmitters = BHP-700

²Variable coupler source:
Bird Electronic Corp., 3030 Aurora Rd.,
Cleveland, OH 44139, (216) 248-1200
Model 4275-20 Coupler, 20-1000 MHz,
"N" male & female, price \$84.00 (June '86)

DETAILED SETUP

IFR FM/AM-1500

Measuring transmitter harmonics

QUICK HARMONIC CHECK

A quick check of harmonic output is easily accomplished on transmitters in the 0.2 to 100 watt range by keying them directly into the **TRANS** port. The top horizontal line of the analyzer is 100 watts because there is an automatic 80dB path switched in between the **TRANS** port and the analyzer when the input power threshold of 100 milliwatts is exceeded.

Look first at the fundamental (F_1) level by setting the center frequency of the analyzer at the transmitter frequency. Jot down the amplitude. (10 watts would read about -40dBm)

Reset the **FREQUENCY** to center the second harmonic ($2 \times F_1 = F_2$). The difference in amplitude is the second harmonic level below the carrier.

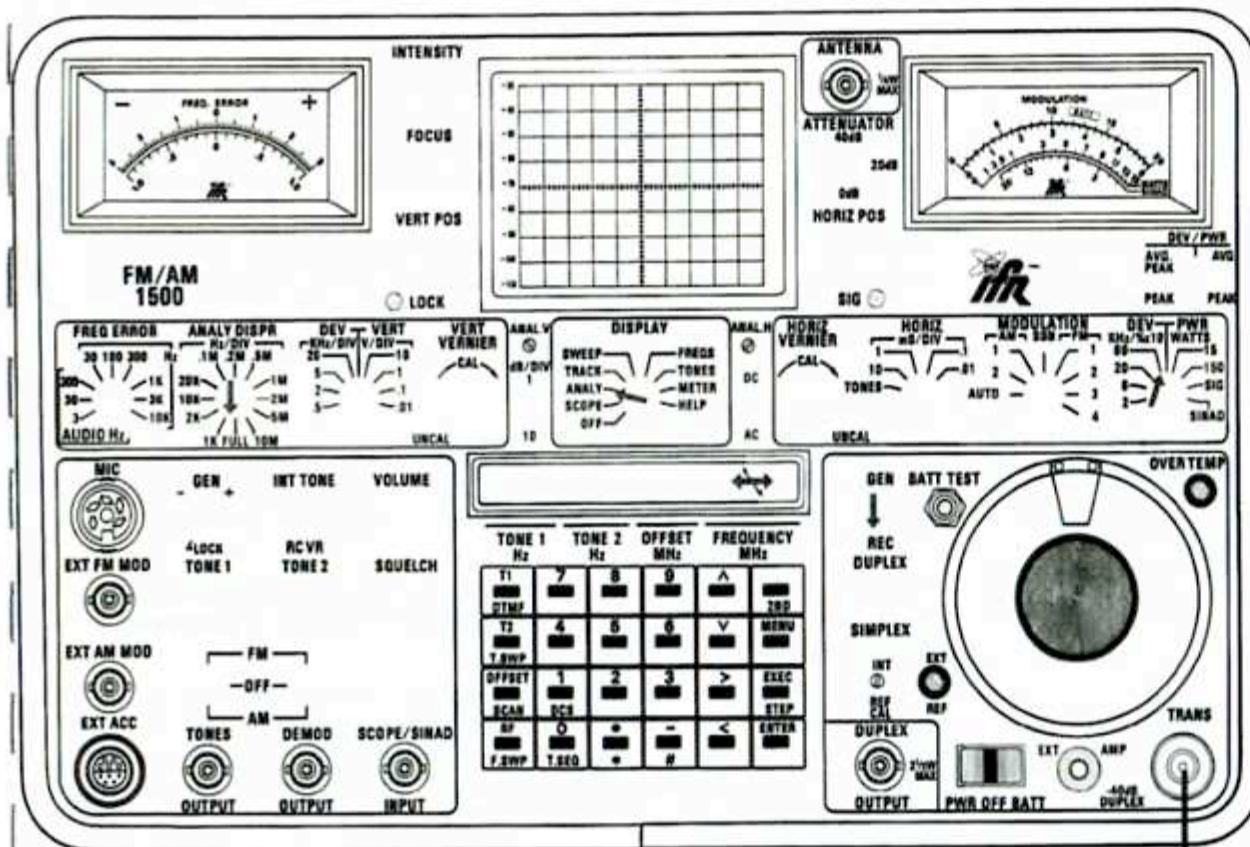

Transmitter
200 mw to 100 watts
(see text for usage outside this power range)

Stage gain measurements using the spectrum analyzer

The spectrum analyzer is a useful tool for measuring *relative* stage gains to isolate problem areas. Defective RF devices frequently cannot be found easily by DC measurements. Probing the input and output will show when there is a major signal loss. We speak of *relative* stage gain measurements because absolute measurements are very difficult due to circuit loading and the detuning effect of any measurement device.

Analyzer input methods

Some method of coupling the signal from the individual RF and I.F. stages to the **ANTENNA** (spectrum analyzer) input is necessary to do stage gain measurements. It can frequently be done with a *sniffer loop* or an RF probe for direct probing.

RF Probes

Because the spectrum analyzer input impedance is 50 ohms, a low impedance RF probe is required to feed it. A typical 10X probe (20 dB) has an input resistance of 500 ohms at DC with an input capacity of 1 pf. A 100X probe (40 dB) looks like 5K Ω with 1 pf. (10X & 100X RF probes are available from Tektronix and others.)

The input impedance of these probes decreases as the frequency increases due to the 1 pf shunt capacity. 1 pf looks like 1600 ohms at 100 MHz but only 160 ohms at 1 GHz.

Which Probe?

Deciding which probe to buy should be influenced by the trade-offs involved.

The 10X probe provides flatter frequency response but circuit loading is greater due to the low DC resistance. Generally the 10X probe is the most useful.

The 100X probe loads high impedance circuits less but its 40 dB loss makes low level signal measurement difficult. The effect of the 1 pf shunt capacity above 300 MHz reduces the input impedance to just slightly more than that of the 10X probe. The 100X probe is best for lo freq I.F.s and H.F. RF work.

A DC block must be used with any probe to prevent analyzer damage due to DC inputs.

APPLICATION NOTE

Sniffer loops

Pickup of RF energy is sometimes more controllable with an inductive pickup or sniffer loop, especially at VHF and UHF. It is not unusual to get considerable capacitive coupling into an RF probe before you touch a tuned circuit. You are actually building a capacitive voltage divider circuit as the pointed probe tip approaches the RF voltage source. Once you actually touch the circuit, it is usually detuned appreciably. A sniffer loop on the other hand, inductively couples energy into the analyzer and usually has less of a detuning effect. You don't have to worry about DC ratings because the sniffer loop element is fully insulated.

The construction of sniffer loops varies slightly depending on the frequency range of intended use. A 2-turn loop is good from about 100 kHz to 50 MHz. Above 50 MHz, just connecting the center connector back to the shield with a 1/4 inch diameter partial turn is sufficient. (See page 6 for *sniffer loop* details)

Stage Gain Measurements

Radios that are separated into modules with coax connectors are the easiest to troubleshoot utilizing stage gain techniques. Some manufacturers even specify the input and output levels of the modules, simplifying the troubleshooting process.

Rarely are commercial radios built with stage gain measurements in mind. Real world stage gain measurements are easiest when you have a good radio to compare with the bad one you're working on.

Injecting a signal into the stage from the generator and measuring the output of that stage with the analyzer in the **TRACK** mode is a straightforward process for receivers. Of course, injecting into the front end at the RF frequency is the easiest. The analyzer can then be used to "sniff" the RF input and output coils, looking for the amplitude increase produced by each "gain" stage.

At the same time, if you have the analyzer on a wide enough dispersion setting, you will also see the HF Local Oscillator above or below the receive frequency. Once you've determined that the RF stage has gain, "sniff" for signal at the 1st I.F. frequency around the mixer. You should see a hump of noise at the I.F. frequency coming from the RF amplifier even if there is no specific signal at the receiver frequency. 

DETAILED SETUP

IFR FM/AM-1500

Using a xmit loop

Now comes the need for the 2nd *Sniffer Loop*. We're not going to use it to "sniff", instead we'll use it as a *source* to couple some I.F. signal into the mixer from the 1500's tracking generator. Reset the **FREQUENCY** to the 1st I.F. frequency.

Injecting the I.F. signal, you can now sniff for it down the I.F. strip to locate trouble spots quickly without trying to find test points or breaking into the circuit.

CAUTION: As you couple the output into the analyzer, you will also radiate some signal. It is possible to produce enough feedback to the input to produce oscillation, especially if you're coupling from end to end through several stages of gain. Watch for narrow, steep-sided peaks in the response curve, a sure sign of regeneration and a precursor to sustained oscillation.

Suggestion: To reduce confusion, color code each sniffer loop assembly with colored vinyl tape on both the loop and connector end. With all of those BNC's on your bench, *anything* to reduce confusion is helpful. They DO multiply and interweave in the night while you're gone.

Stage gain measurements using the spectrum analyzer

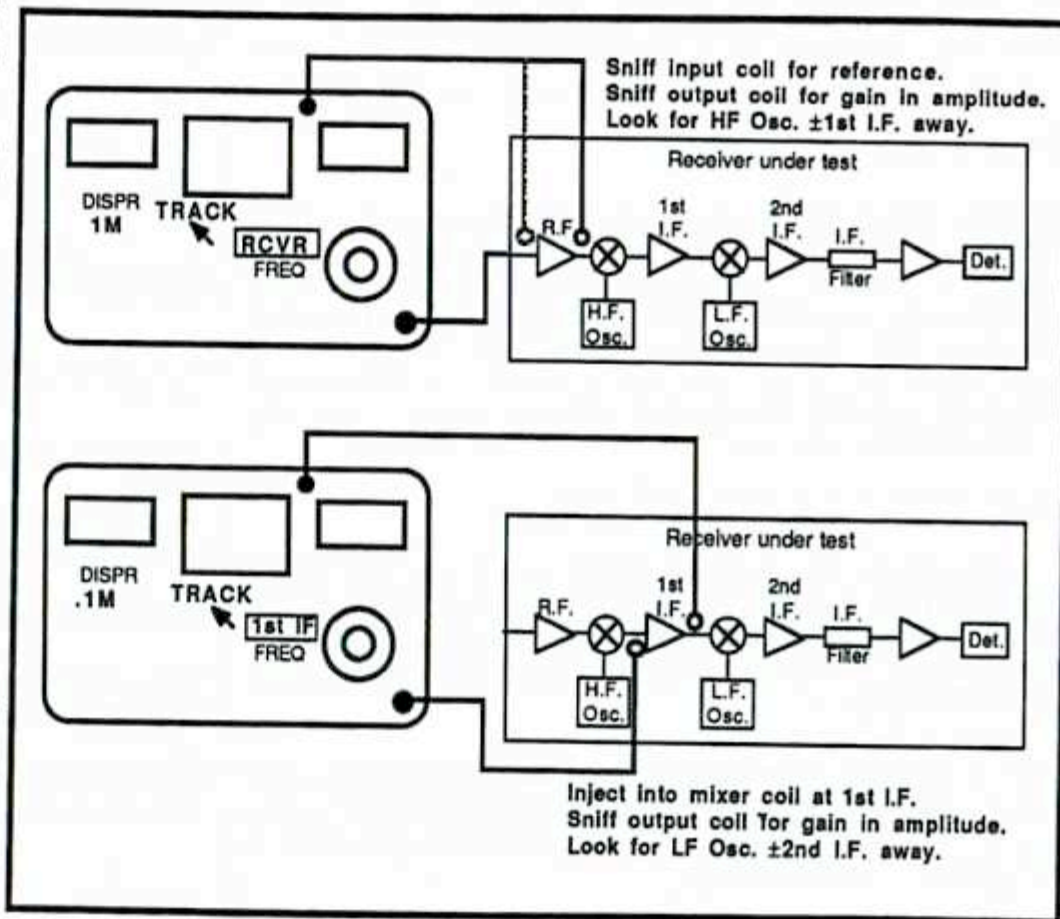

Analyzing receiver desense caused by intermodulation distortion

When intermodulation problems occur, you must first determine whether they are generated within the receiver by mixing products or if they are produced by mixing in an external non-linear device such as corroded antenna connections or in a nearby transmitter.

Externally or Internally produced?

Eliminate the receiver first by splitting the signal from the antenna and feeding both the receiver in question and the 1500's receiver. Listen to the receiver for the intermod and look for it in the analyzer display at the receive frequency. If you hear it from the receiver and do not see it on the analyzer, you've *only* determined that it is not an *on channel* intermod produced externally. It still could be a mixing product generated externally and interfering on a spurious response frequency within the receiver or it could be a mix within the receiver.

To determine if the mix is within the receiver:

Next, lightly couple the receiver's 1st IF output into the 1500's ANTENNA port with a sniffer loop. Tape the sniffer loop down so that the sniffed signal will be constant. When the interfering signal is heard, switch to 1 dB/DIV and set the top of the signal to the top of the screen with the VERT POS control.

Install a 3 dB attenuator in the outside antenna line. If the analyzer signal level drops *appreciably* more than 3 dB, the intermod is produced within the receiver. If it only drops 3 dB, the source is external, probably in a nearby transmitter or antenna system.

To determine if the mix is within the suspected transmitter:

A tuned isolator is needed in the suspected transmitter's output line to provide different forward and reverse loss factors.

Measure the forward and reverse loss at the intermod frequency. (more on insertion loss measurements on pages 44-45)

Connect the RF Coupler's output to the 1500's ANTENNA input.

Adjust the coupler to establish a reference level of the intermod when it next appears.

Install isolator and note the attenuation in the intermod.

If the intermod signal drops by the forward attenuation of the isolator, the intermod is not being caused by this transmitter.

If the intermod signal drops by the reverse attenuation of the isolator, you've found the offender.

DETAILED SETUP

IFR FM/AM-1500

Analyzing receiver desense caused by intermodulation distortion

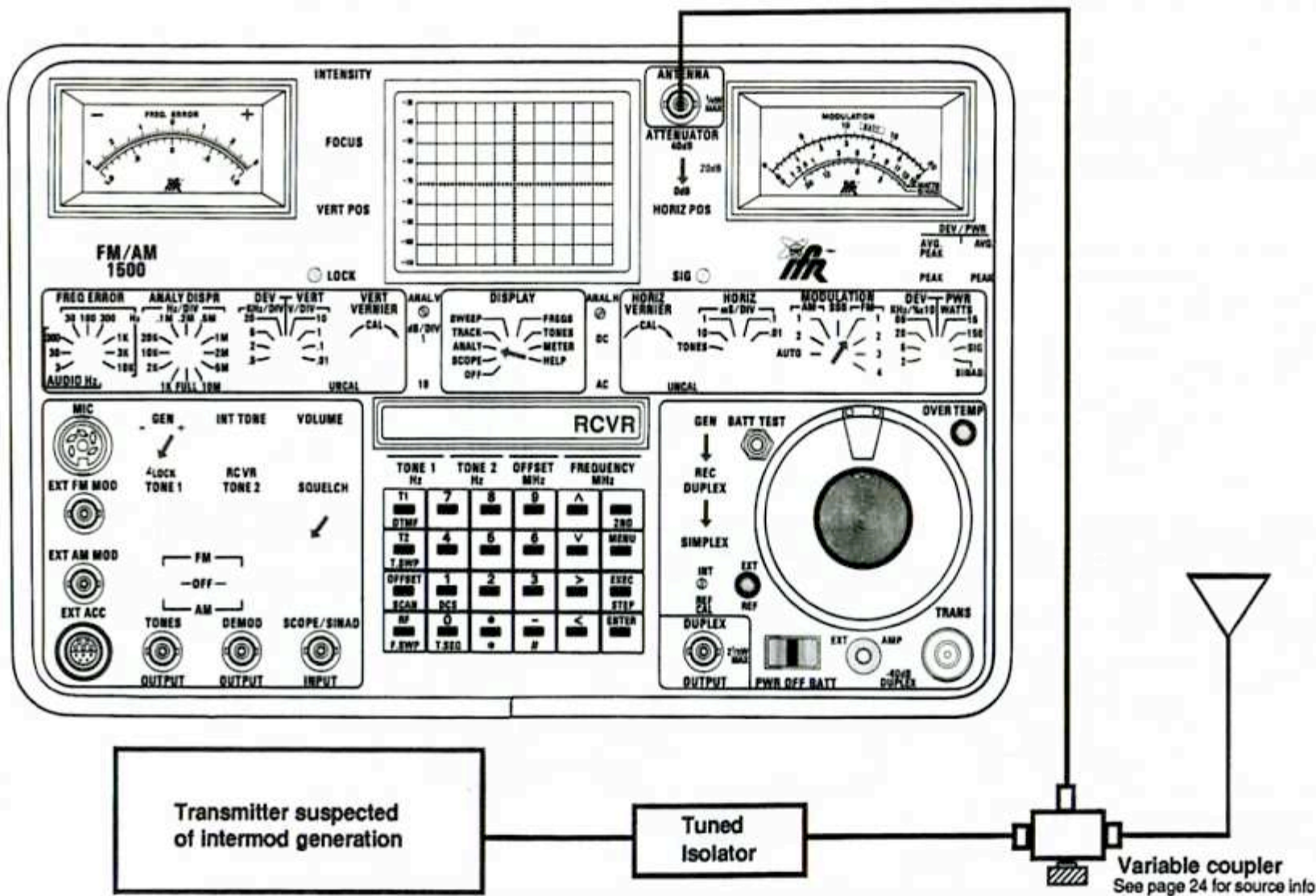

APPLICATION NOTE

Measuring isolation and insertion loss in Tx-Rx switches

T-R relays can be a source of several problems. Low transmitter power, poor receiver sensitivity and even intermod interference problems.

TRANSMITTER POWER LOSS

Transmit power loss caused by the relay is easily isolated by measuring output power with and without the relay.

RECEIVER SENSITIVITY LOSS

Receiver sensitivity loss is isolated by measuring the transmission loss at the receiver

frequency. Sensitivity loss is more apt to be an intermittent problem due to the lack of power to punch through the thin corrosion layer on the receive contacts.

T-R RELAY MAY BE AN INTERMOD SOURCE

Corrosion on contacts may act as a diode, creating an unwanted mixer when excited by strong RF signals from the antenna.

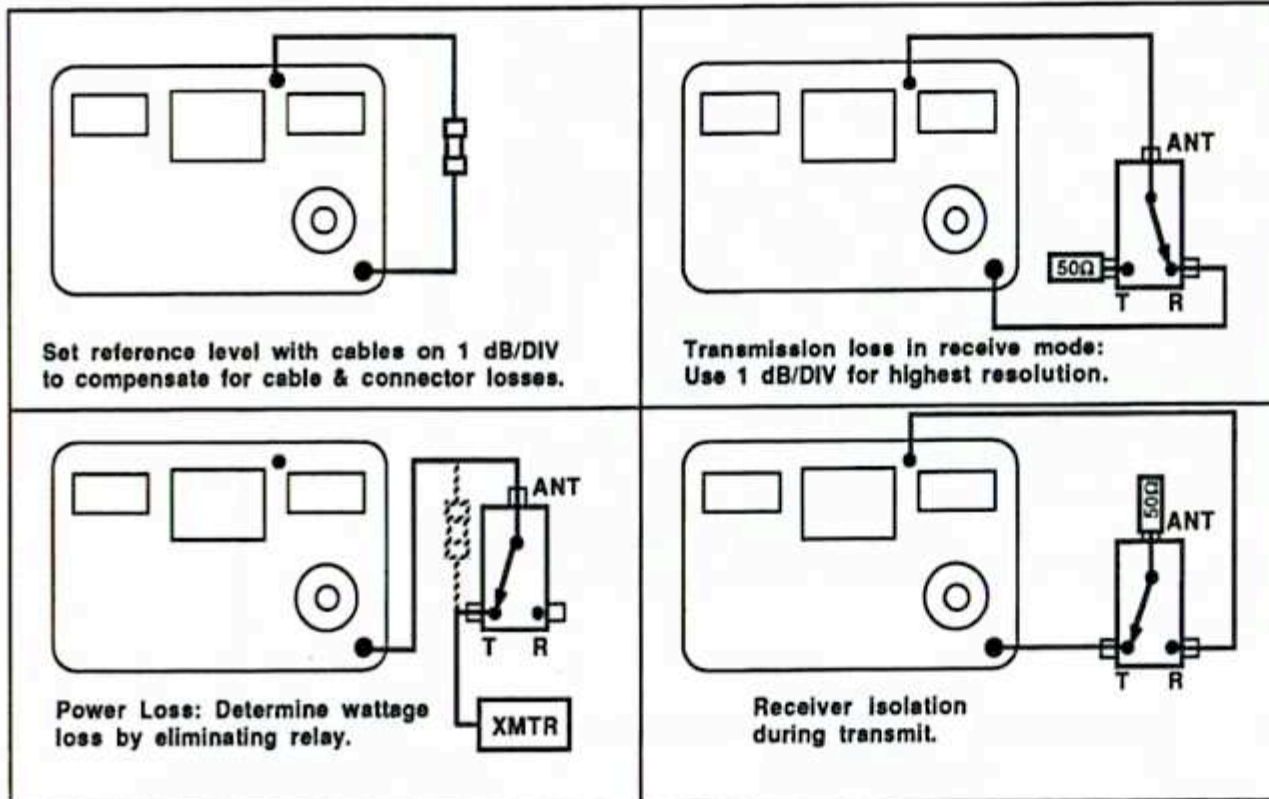

DETAILED SETUP

IFR FM/AM-1500

Measuring isolation and insertion loss in Tx-Rx switches

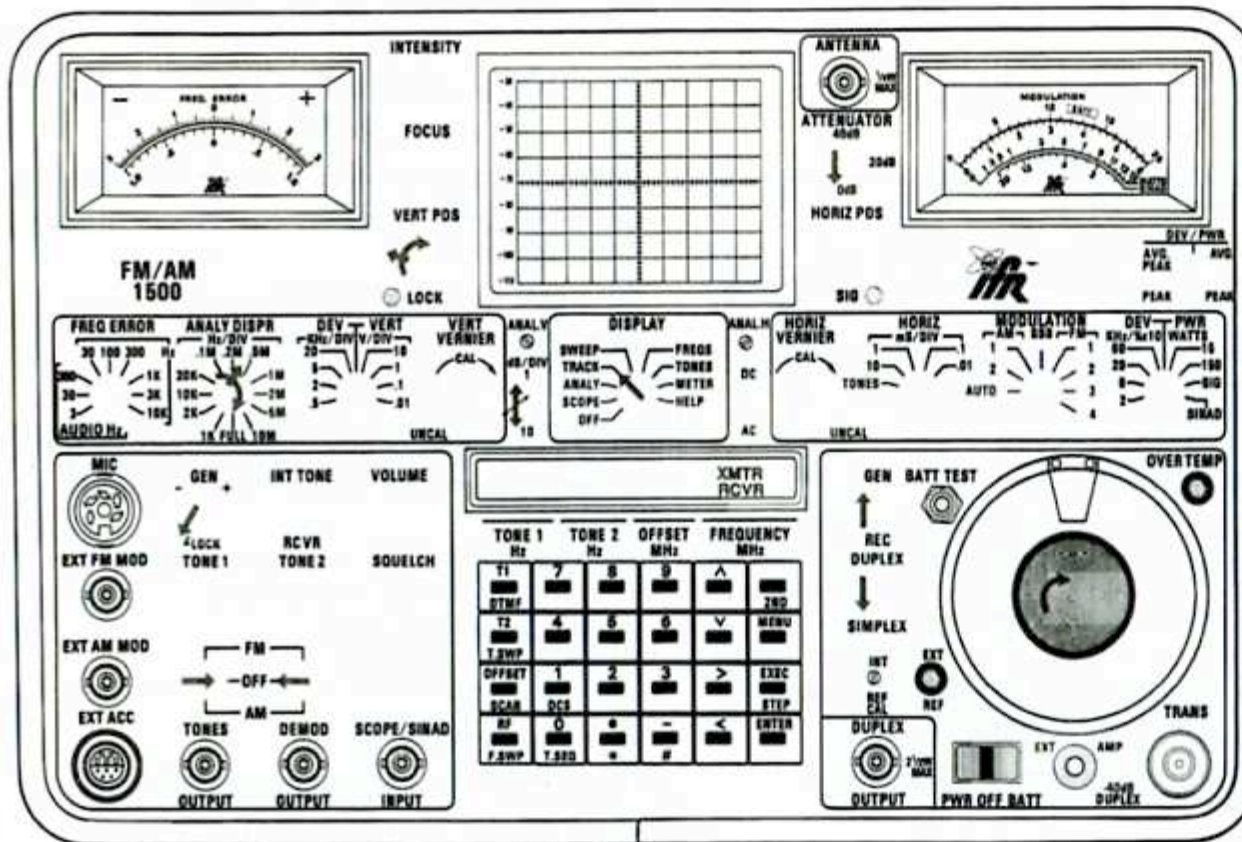

See facing page for actual connections.

Use 10dB/DIV for loss measurements of 10dB or more.

Use 1dB/DIV for higher resolution measurements. (≤ 10 dB)

Use VERT POS to re-center reference.

Always "calibrate out" cable and connector loss at each frequency of interest.

Monitoring SSB & ACSB testing

SSB

Single Sideband signals are easily monitored with the 1500's **MODULATION** switch in the **SSB** position. An accurate phase locked beat frequency signal [BFO] is automatically injected on the 1500's last IF frequency.

SSB Frequency error

Setting the frequency of a SSB transmitter is easiest when the transmitter can be switched or jumpered into a CW mode. Sometimes the carrier balance control can be misadjusted slightly to produce a small CW signal. The frequency can then be read conventionally on either the digital or analog Error Meter. (See pages 34-35 for 0.1 Hz resolution method.)

If CW operation is not practical, the precision frequency audio generator capability of **TONE 1** is used to modulate the SSB transmitter with a 1,000.0 Hz tone.

The 1500's **FREQUENCY** is then set 1 kilohertz above or below the suppressed carrier frequency depending upon whether the upper or lower sideband is used.

The frequency error can then be read directly on the digital **DISPLAY** in the **METER** position or on the analog **FREQ. ERROR** meter.

Marine radio note: To achieve the ± 20 Hz accuracy required by FCC for marine HF radios, the oven option must be installed in the 1500.

ACSB TRANSMITTER TESTS

To confirm compressor performance:

Monitor through the **ANTENNA** port as shown on facing page.

Set **FREQUENCY** to suppressed carrier of ACSB signal.

With modulation turned off, key transmitter and note that **FREQ ERROR** meter reads the frequency of the pilot tone.

Modulate transmitter with **TONE 1** at 1000.0 Hz. When modulation is at maximum, the **FREQ ERROR** meter should read 1 kHz.

ACSB Frequency error

Use either digital or analog **FREQ ERROR** meter to measure the frequency error of the *unmodulated* ACSB signal. The unmodulated signal will be 3.1 kHz above the suppressed carrier.

Viewing transmitter modulation envelope

Reset **DISPLAY** to **SCOPE**.

Modulate the transmitter with **TONE 1** set at 1800 Hz.

Adjust **TONE 1** level to display a modulation envelope. Adjust **HORIZ VERNIER** for a stable display.

Overdriving the transmitter output causes flattening of peaks. Watch for parasitic oscillations which appear as a fuzzy halo on the envelope.

APPLICATION NOTE

ACSB RECEIVER TESTS

SRTM (Standard Receiver Test Modulation)
[test signal with pilot and 1 kHz test tone.]

Set **FREQUENCY MHz** to the suppressed carrier +1kHz.

Set **MODULATION** switch to **AM1**.

Set **TONE 1** to 2100.0 Hz. Set the modulation level to 63%.

To measure SINAD:

Connect audio output to **SINAD** input.

Increase RF level to achieve 12 dB SINAD.

Checking pilot capture & AFC tracking

After achieving 12 dB SINAD, vary **TONE 1** frequency in hundred hertz steps from 1400 Hz to 3000 Hz to make sure that receiver tracks the pilot tone. SINAD indication should remain constant.

Receiver capture of pilot: Set radio squelch to threshold with no RF. Increase RF level until squelch opens.

Vary **FREQUENCY MHz** ± 500 Hz.
SINAD should remain constant.

Checking receiver expander

Set **FREQUENCY MHz** to suppressed carrier frequency.

Set **TONE 2** to 1000 Hz. Set modulation to 20% with **TONE 2** level control.

Set **TONE 1** to 3100.0 Hz. Increase **TONE 1** to obtain 40% total modulation.

View radio's 1 kHz speaker audio on **SCOPE**.

Increase / decrease 1 kHz (**TONE 2**) level. Audio level should change correspondingly.

DETAILED SETUP

IFR FM/AM-1500

Monitoring SSB & ACSB testing

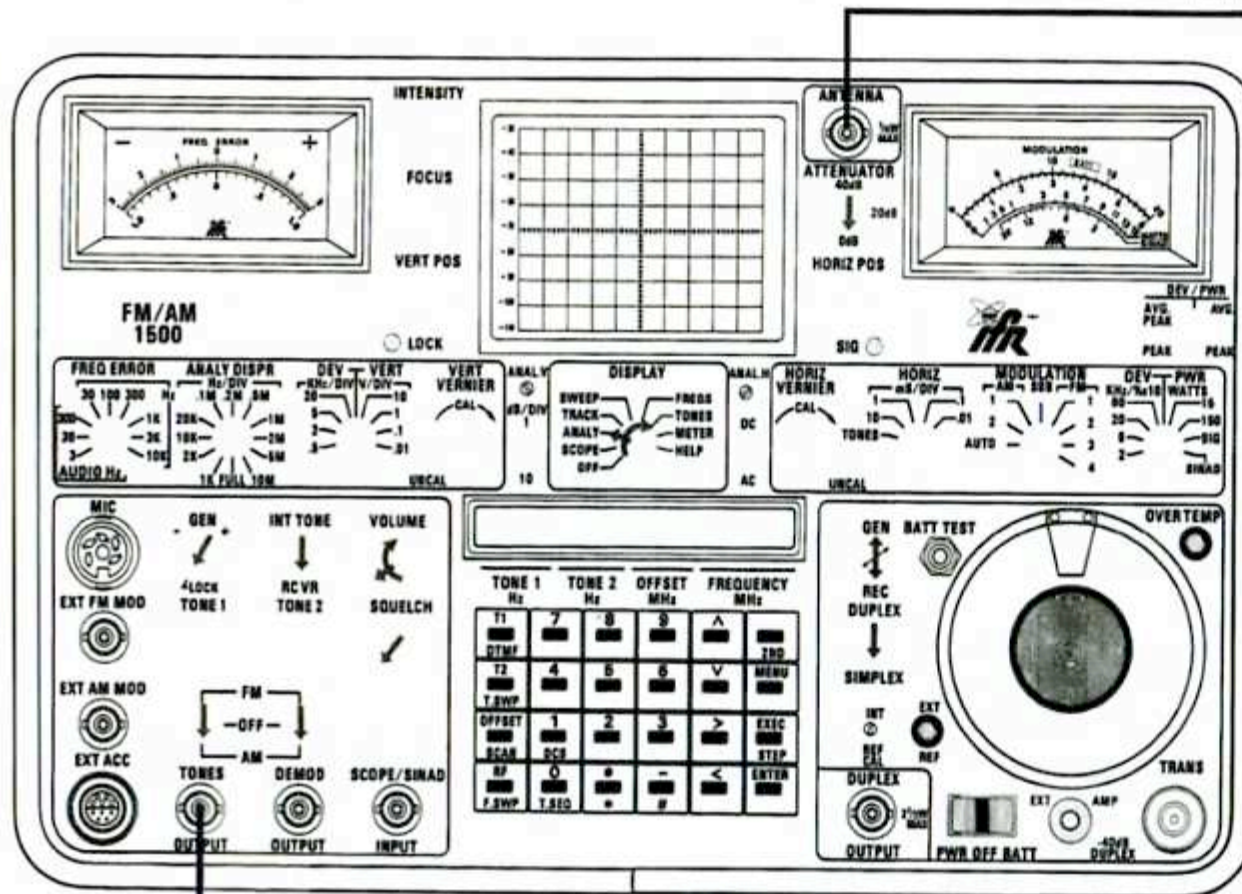

RECEIVER TEST SETUP

Sensitivity is measured using the same connections as any other radio. (see page 10-11 for SINAD setup)

TRANSMITTER TEST SETUP

A coupler and an external load are necessary on SSB & ACSB if the RF output with no modulation is less than 100 milliwatts.

The 1500's TRANS port has a 100 mw power detector that switches in an 80 dB path between the TRANS and ANTENNA ports for viewing transmitter signals on the analyzer.

With average power levels varying through this 100 milliwatt threshold during modulation, the 1500 will toggle back and forth.

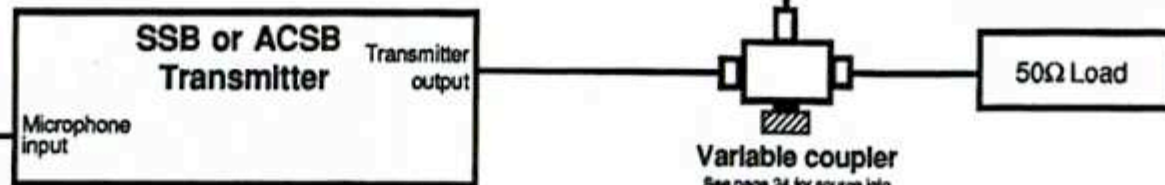

Variable coupler
See page 24 for source info

Synchronizing Simulcast Transmitters

Simulcasting requires that the RF frequency of all of the transmitters be set very close to each other. The 1500 is capable of measuring the frequency direct or off the air with a resolution of $\pm .1$ Hz. The needle trend of the analog **FREQ. ERROR** meter makes coarse frequency setting easy. The digital **FREQ ERROR** shown on the **DISPLAY** in the **METER** position provides ± 1 count resolution.

Off-the-air checking would of course require that you have control of each individual transmitter from the measurement site or be able to discriminate between received signals so you know which transmitter you're receiving.

Note: The standard 1500 will resolve RF signals to 0.1 Hz, but the frequency stability required for simulcast testing requires the oven oscillator option be installed.

Allow the 1500 at least 15 minutes warm-up from a cold start before attempting accurate frequency setting. The oven can be kept hot between transmitter sites by using the cigarette lighter plug to run the 1500 on the service vehicle battery.

CAUTION: It is wise to unplug the cord during the vehicle starting process to protect the 1500 from those brutal transients!

APPLICATION NOTE

For 1 Hz resolution

The 30 Hz **FREQ. ERROR** position on the analog **FREQ. ERROR** meter provides 1 Hz resolution so it's as easy as setting the 1500's **FREQUENCY** to the desired and tweaking first one transmitter to zero and then the other to zero on the error meter.

The digital error display shown when the **DISPLAY** switch is in the **METER** position will also reflect the frequency error ± 1 Hz.

For 0.1 Hz resolution.

Tenth Hertz resolution is available by switching the **MODULATION** to **SSB**. In the **SSB** position a phase locked beat frequency oscillator is injected into the 1500's last IF. This BFO produces an audio beat note which may then be compared to **TONE 1** with the difference displayed on the **FREQ. ERROR** meter and read out on the CRT digital **DISPLAY** in the **METER** position.

EXAMPLE

Suppose that you wanted to set a transmitter to a frequency that was not on an even hundred hertz step, say 155.500145. 145 Hz above 155.5.

Setting the 1500's **FREQUENCY MHz** will get you to 155.5001. With the **FREQ. ERROR** switch in the 100 Hz position you can see the +45 Hz error on the meter.

Key in 45.0 Hz in **TONE 1** and switch the **FREQ. ERROR** switch to **300 Hz AUDIO**. Tweak the transmitter frequency to center the needle on the **FREQ. ERROR** meter. Switch down to the 3 Hz position to center it within a tenth hertz.

DETAILED SETUP

IFR FM/AM-1500

Synchronizing Simulcast Transmitters

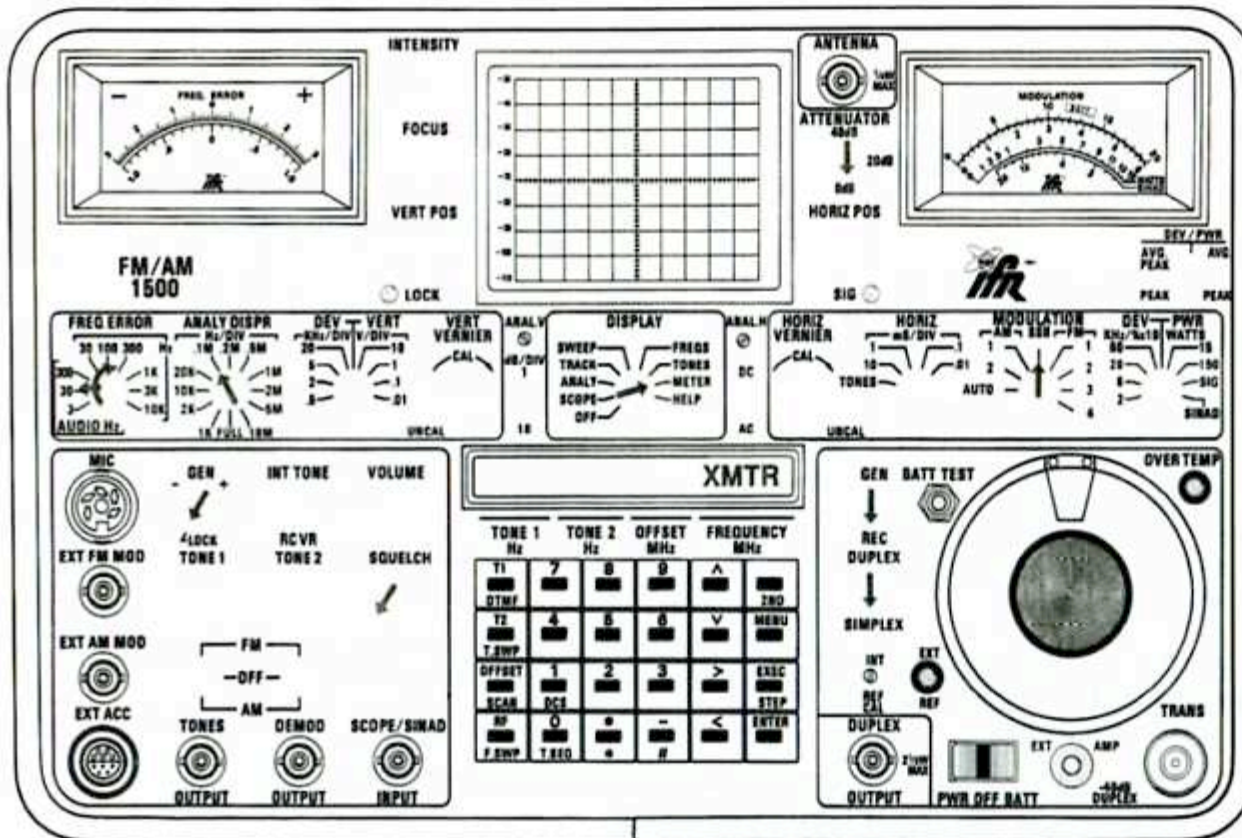

Transmitter "A"

Transmitter "B"

Measuring Antenna Isolation

With antenna site space a valuable commodity, multiple antennas in close proximity are a fact of life. Isolation between antennas becomes important to reduce the possibility of intermod interference.

To measure the isolation between antennas, one antenna is fed with the tracking generator (TRANS port) and the 1500's receiver / spectrum analyzer (ANTENNA) is connected to the other antenna.

The transmission loss versus frequency curve is then displayed directly on the analyzer.

For most UHF and low gain VHF antennas, one measurement is usually sufficient because the antenna selectivity doesn't affect the measurement appreciably. In the adjacent example, there was essentially no difference in the measurement curves because both antennas were cut the same.

When high gain/narrow band antennas are used, the measurement procedure should be done twice. Swap coax lines and re-measure the loss. The curves will be different due to the selectivity of each antenna.

Check for possible front end overload levels before making this measurement by setting the FREQUENCY to 500 MHz and the ANALY DISPR to FULL. Look for any signals that exceed the top of the display. If there are any, switch in the 20dB ATTENUATOR.

Re-couple the connecting coax test cables to each other and increase the RF output to re-establish a "top of the screen" reference.

EXAMPLE

A single four stack collinear array was split into two 2 stack collinear UHF arrays, separated by about 10 feet vertically.

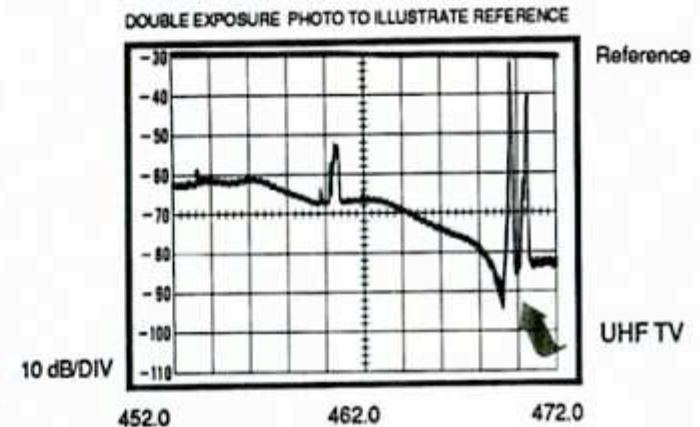

The 35-40 dB isolation between these two antennas proved to be marginal and created some intermod problems.

Control settings for the above measurements:

DISPLAY: TRACK
FREQUENCY: 462.0 MHz
ANALY DISPR: 2 MHz/DIV
DB/DIV: 10
GEN/REC: GEN
ATTENUATOR: 0dB
RF OUTPUT: ~ -30 dBm

DETAILED SETUP

IFR FM/AM-1500

CAUTION:
Be sure to discharge *any outside* antenna coax before connecting to the 1500's ANTENNA port to reduce the possibility of static damage to the front end.

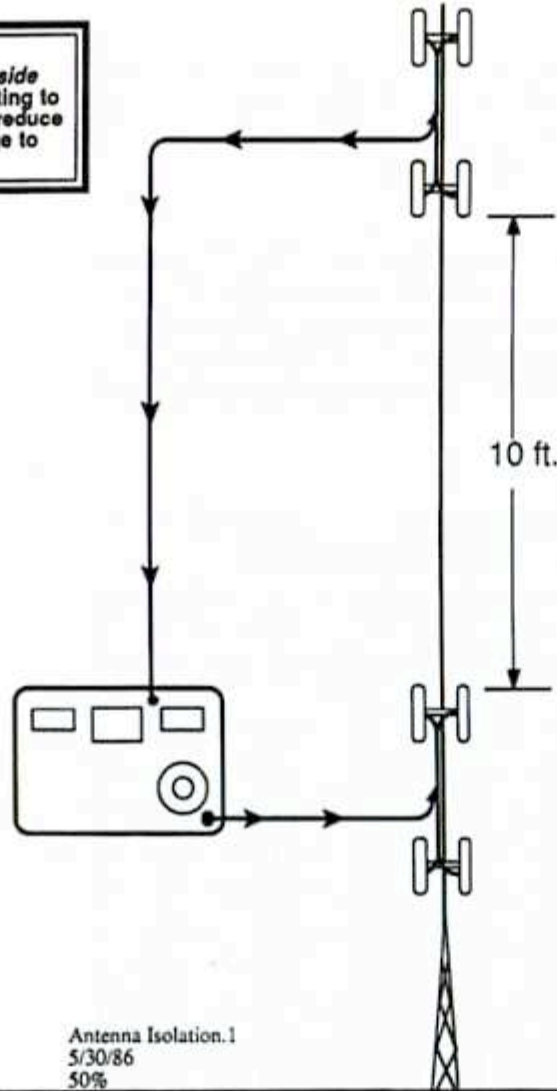

Antenna Isolation.1
5/30/86
50%

Measuring Antenna Isolation

APPROXIMATE ISOLATION PROVIDED BY ANTENNA SEPARATION

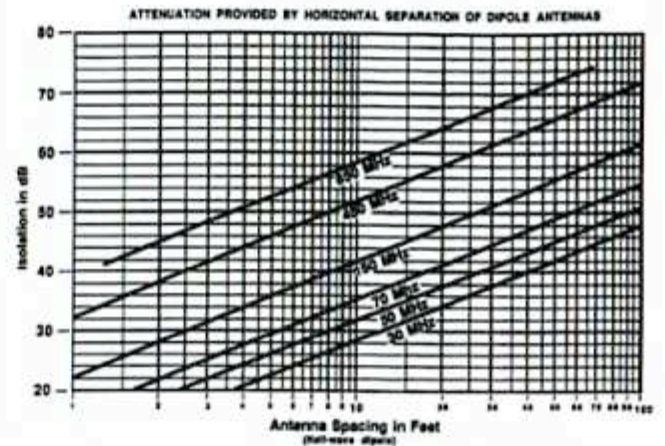
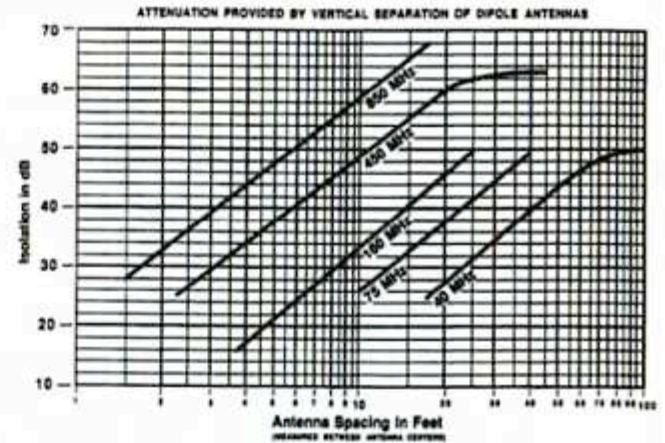

Tuning Antennas for Minimum VSWR

Using a VSWR BRIDGE

A VSWR bridge¹ used with the tracking generator / spectrum analyzer can provide more useful antenna information than a directional wattmeter. The VSWR bridge method will tell you the frequency where resonance occurs. By knowing the resonant frequency, you'll know *which way* to tune it. You won't have to tell the boss, "I cut it off and cut it off and it's still too short."

NORMAL procedure

The bridge method is simple, just connect the bridge as shown leaving the DUT ("DEVICE UNDER TEST") port *open*. Raise the RF output to set the trace to the top line at the center of the screen for your REFERENCE. Connect the antenna to the DUT port and read the return loss at center screen. The deeper the dip, the more power is being absorbed. The width of the dip is determined by the bandwidth of the antenna. A "broadbanded" antenna will have more than one tuned element and will display more than one dip.

HIGH RESOLUTION procedure

The 10 dB/DIV scale will show major antenna deficiencies. Definitive measurement of VSWR of less than 2 to 1 is best accomplished by using the 1 dB/DIV setting to increase the display resolution.

The return loss is then read using the dB scale of the RF output dial.

Connect the bridge as shown leaving the DUT port open. Set the RF output to **-40dBm**. Bring the trace back to mid-screen with the VERT POS control, this becomes your REFERENCE POSITION. Connect the device being tested to the DUT port. Bring the trace back to the REFERENCE POSITION by increasing the RF level to compensate for the RETURN LOSS.

Subtracting the *new* RF dial reading from the -40 dBm reference gives you the RETURN LOSS. Use the CONVERSION CHART to determine VSWR.

RETURN LOSS - VSWR - REFLECTED POWER CONVERSION CHART					
Return Loss dB	VSWR	Reflected Power %REFL	Return Loss dB	VSWR	Reflected Power %REFL
1.0	17.4	79.4	16.0	1.38	2.5
2.0	8.72	63.1	17.0	1.33	2.0
3.0	5.85	50.1	18.0	1.29	1.6
4.0	4.42	39.8	19.0	1.25	1.3
5.0	3.57	31.6	20.0	1.22	1.0
6.0	3.01	25.1	22.0	1.17	.6
7.0	2.61	20.0	24.0	1.13	.4
8.0	2.32	15.8	26.0	1.11	.3
9.0	2.10	12.6	28.0	1.08	.16
10.0	1.93	10.0	30.0	1.07	.10
11.0	1.78	7.9	32.0	1.05	.06
12.0	1.67	6.3	34.0	1.04	.04
13.0	1.58	5.0	36.0	1.03	.03
14.0	1.49	4.0	38.0	1.03	.02
15.0	1.43	3.2	40.0	1.02	.01

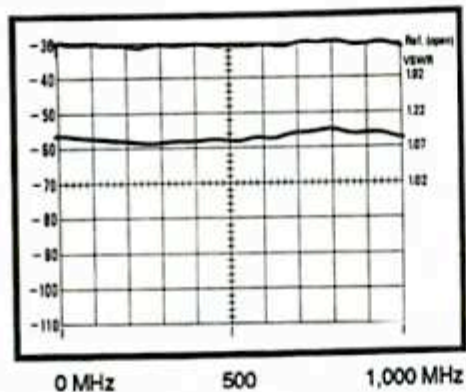

Reference = Bridge with open N to BNC adaptor.

Scope photos are double exposures to show both reference and unknown VSWR.

50 Ω BNC termination connected directly through N to BNC adaptor.

FREQUENCY = 500 MHz
ANALY DISP = FULL

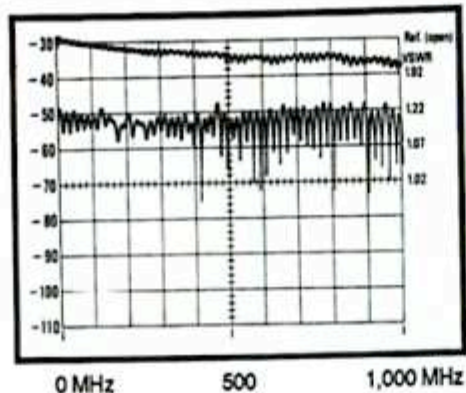

Reference = 17 ft. RG-58 with open BNC barrel.
Reference droop due to coax loss.

Same 50 Ω termination as above except it's on the end of 17 ft. of RG-58 coax.

Reflected power ripples, caused by summing of reflection vectors, must be averaged to approach accurate VSWR.

MORAL: Connect bridge DIRECT to antenna if possible.

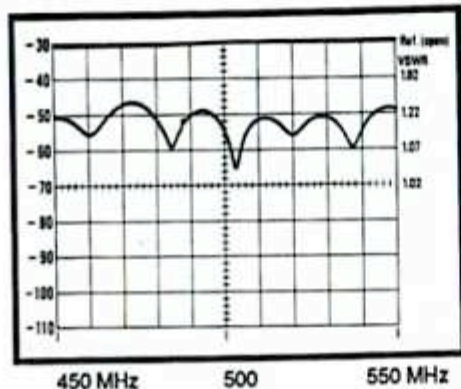

Reference = 17 ft. RG-58 with open BNC barrel.
Reference droop due to coax loss.

Same 50 Ω termination at the end of 17 ft. of RG-58 coax.

ANALYZER DISPERSION set at 10 MHz / DIV.

Dotted line indicates average of ripple.

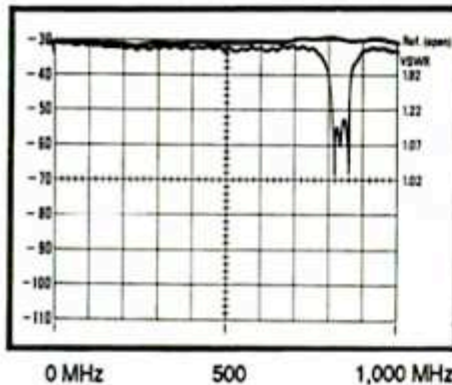

Window mounted Cellular antenna fed with 7 ft. of RG-58.

Reference = Bridge with open N to BNC adaptor.

FREQUENCY = 500 MHz
ANALY DISP = FULL

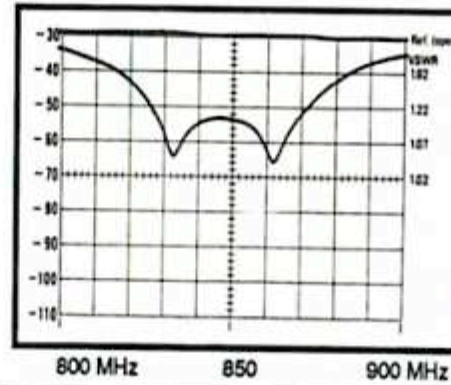

Same window mounted Cellular antenna.

Fed with short coax (34") to reduce ripple effect.

Note that there are only **two** tuning dips. They will both move when the tuning screw on the antenna is adjusted.

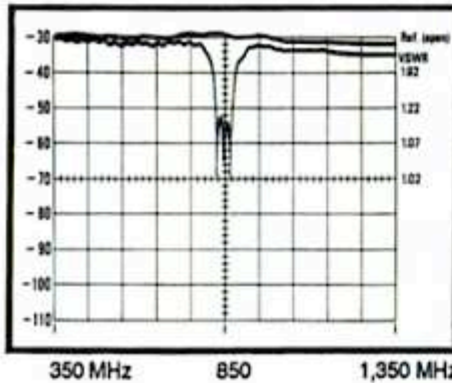

Same window mounted Cellular antenna.

Analyzer center frequency moved to 850 MHz to center response curve.

FREQUENCY = 850.00

NOTE: The analyzer response is inactive above 1 GHz.

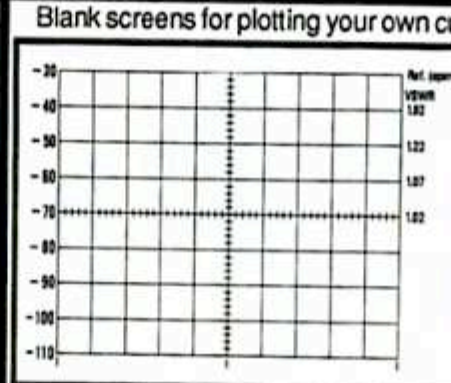

Blank screens for plotting your own custom VSWR images for reference.

Notes

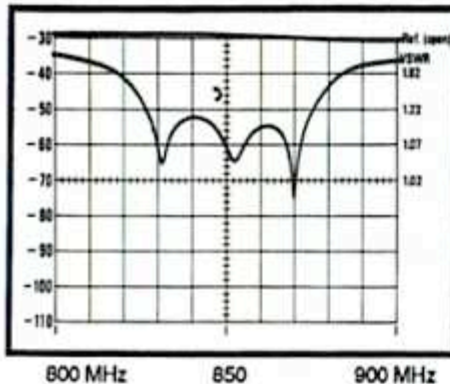

Same window mounted Cellular antenna.

ANALY DISPR reset to 10 MHz / DIV.

Of the 3 dips shown, one is caused by coax ripple, but overall VSWR is considerably better than manufacturer's 1.9 to 1 spec.

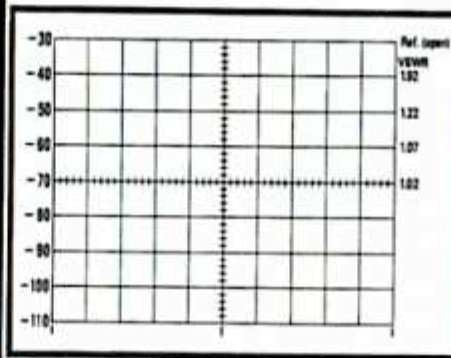

Notes

DETAILED SETUP

IFR FM/AM-1500

Tuning Antennas for Minimum VSWR

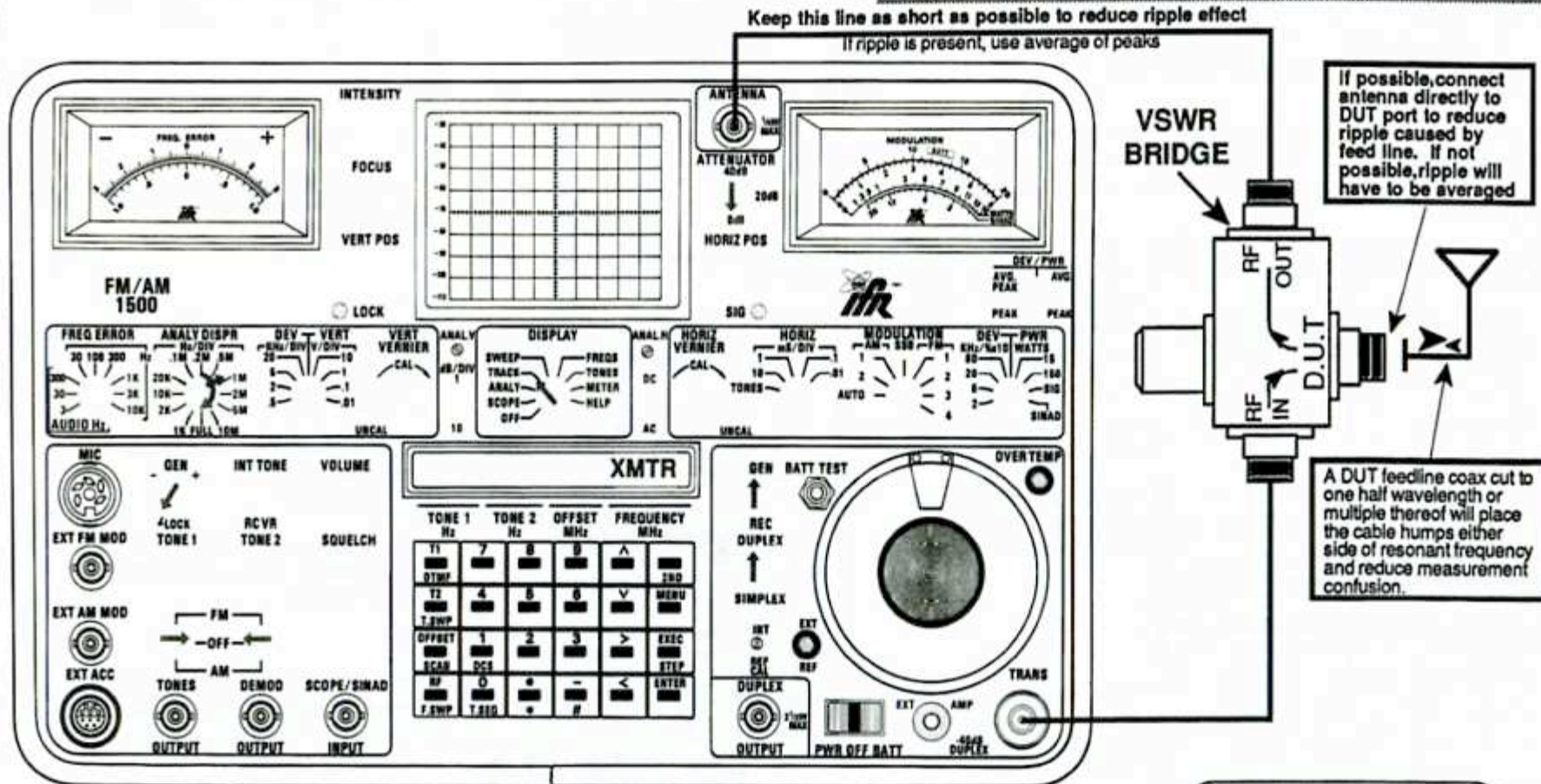

REMEMBER

The overall VSWR will be no better than the poorest element in the measurement.
Beware of inter-series adaptors, especially home-made ones.

¹ VSWR bridge source:
Model 62NF50, 10-1000 MHz
\$325, June 1986
Wiltron
805 E. Middlefield Road
P.O. Box 7290
Mountain View, CA 94042
(415) 969-6500

Cable Fault Location and Finding Tuned Stub Lengths

The tracking generator plus the computation power in the 1500 simplifies cable fault location. With the cable fault locator, you can pinpoint the exact distance to a fault.

Fortunately most cable faults are shorts or opens, rarely are they 50Ω . You know that when you look into a shorted half wave stub at its resonant frequency, it looks like a short. Conversely, an open quarter wave stub looks like a short.

The cable fault locator counts on the fact that a discontinuity, normally either a short or open, will reflect a short every half wavelength when a swept frequency is applied.

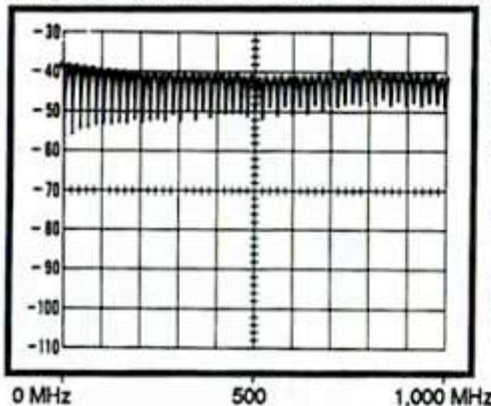

Unknown cable attached with "T" at TRANS port.

FREQUENCY: 500.00 MHz
ANALY DISPR: FULL
RF Output: -40 dBm

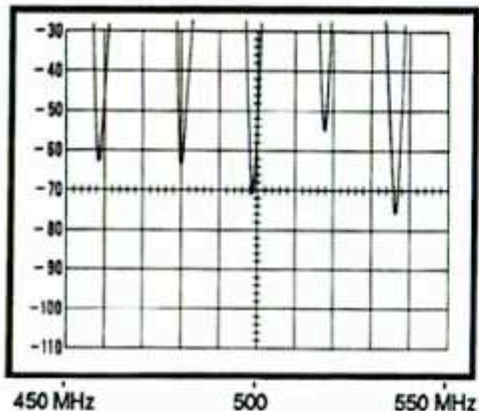

Same unknown cable as above but the horizontal resolution has been expanded by resetting ANALY DISPR to 10M.

Vertical resolution is increased by switching to 1 dB/DIV.

APPLICATION NOTE

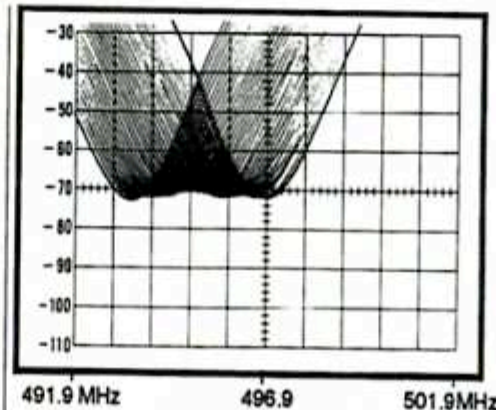

Same unknown cable as left column scope photos. Further horizontal expansion by setting ANALY DISPR to 1M.

Jog FREQUENCY down .1 MHz per step to bring the closest dip to center screen.

Record FREQ. (example: 496.9)

Jog FREQUENCY up until next dip is centered. Hit ENTER key to save that freq. and release keypad.

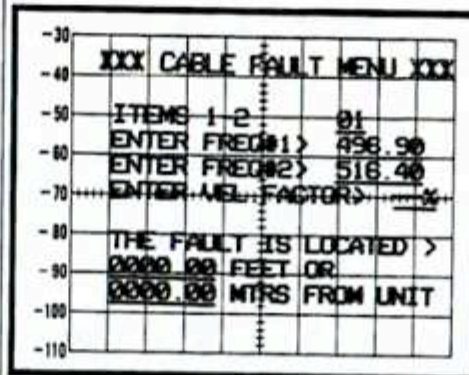

Switch DISPLAY to FREQS.

Key MENU ^, ^, ^ to bring up CABLE FAULT MENU.

ENTER, >, then key in the freq. you recorded in FREQ #1.
Example: 496.9

>, then key in the freq. saved in the FREQUENCY window in FREQ #2.
Example: 516.4

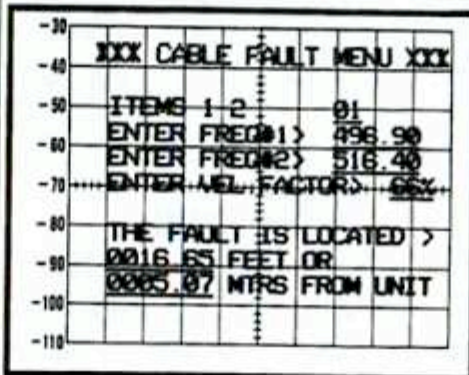

>, then key in the two digit VEL. FACTOR based on cable dielectric, see table on facing page. (example: 66%)

ENTER will complete the function and the calculated distance to the fault in feet and meters will be displayed.

DETAILED SETUP

IFR FM/AM-1500

Cable Fault Location and Finding Tuned Stub Lengths

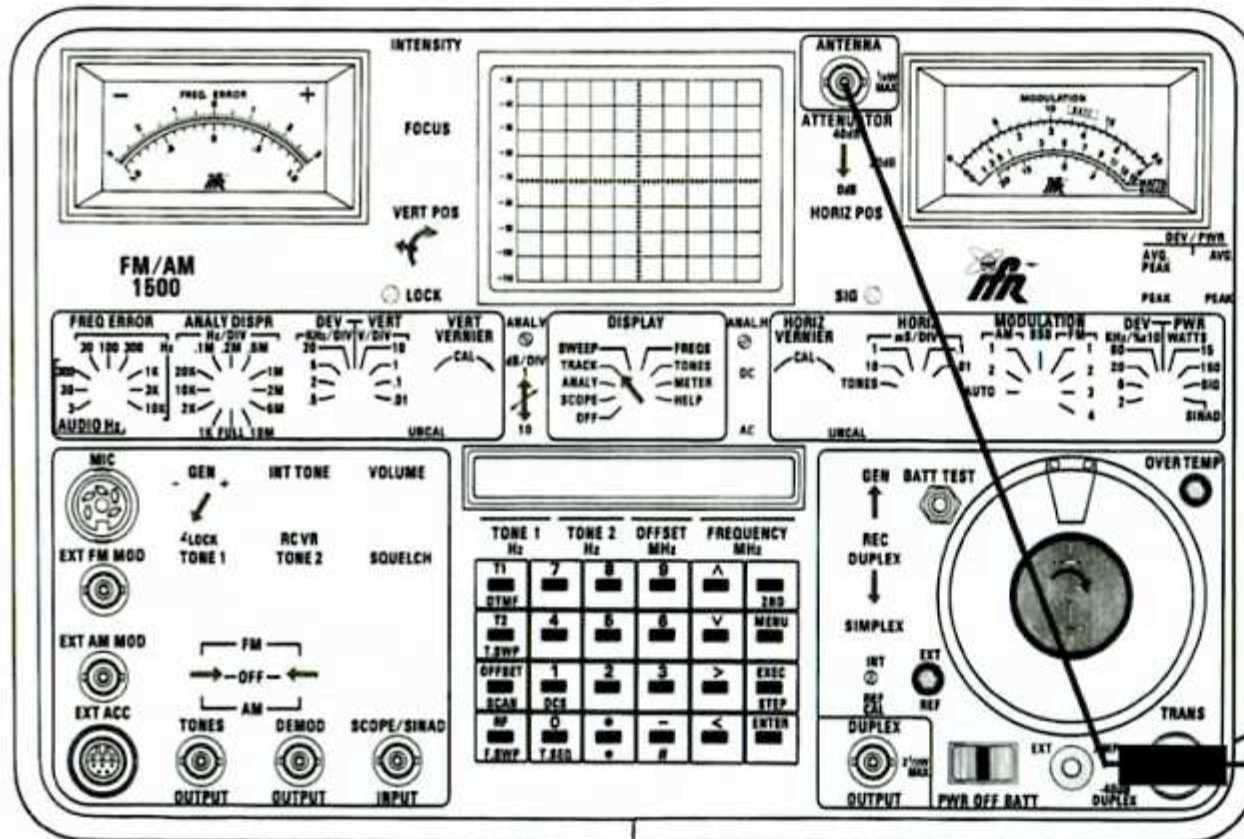

Note:

The Cable Fault Locator accuracy is dependent on the exact frequency of the center of the dip. Use 1dB/DIV and a narrow DISPR setting for highest resolution.

VELOCITY FACTOR

Cable Dielectric Velocity

Solid Polyethelene.....	65.9%
Foam Polyethelene.....	80.0%
Foam Polystyrene.....	91.0%
Air Space Polyethelene.....	84-88%
Solid Teflon.....	69.4%
Air Space Teflon.....	85-90%

Using the Cable Fault calculator for determining coax stub length:

Suppose you want to cut a half wave stub of RG-58 coax at 153 MHz. Just enter 0 MHz in **FREQ #1** and 153 MHz in **FREQ #2**. You know from experience that RG-58 is polyethelene, so enter 66 in the **VEL. FACTOR** window. When you hit the **ENTER** key, the actual coax length for the half wave stub will be displayed. Fine tuning: Set the **FREQUENCY** to 153.00 and cut coax to center the dip.

Measuring Center Frequency Insertion Loss and 3dB Points on Cavities

The tracking generator/spectrum analyzer provides an instant graphic readout of loss across the band for duplexers and cavities. The 1 dB/DIV range allows resolution to .5 dB.

Conversion Chart dB down vs % power loss					
dB	%	dB	%	dB	%
.10	2.3	1.0	20.6	2.5	43.7
.20	4.5	1.1	22.4	3.0	50.0
.25	5.3	1.2	24.1	4.0	60.2
.30	6.7	1.3	25.9	5.0	68.4
.40	8.8	1.4	27.6	6.0	74.9
.50	10.9	1.5	29.2	7.0	80.0
.60	12.9	1.6	30.8	8.0	84.2
.70	14.9	1.7	32.4	9.0	87.5
.75	15.9	1.8	33.9	10.0	90.0
.80	16.8	1.9	35.4	15.0	96.8
.90	18.7	2.0	36.9	20.0	99.0

Conversion Chart Power ratios to dB			
Power Ratio	dB	Power Ratio	dB
0.10	-10	1.00	0
0.13	-9	1.26	1
0.16	-8	1.58	2
0.20	-7	2.00	3
0.25	-6	2.51	4
0.32	-5	3.16	5
0.40	-4	4.00	6
0.50	-3	5.01	7
0.59	-2	6.31	8
0.74	-1	7.94	9
1.00	0	10.00	10

These photos show various curves produced by a single VHF bandpass cavity which is also usable at UHF. (All photos are multiple exposures to show reference.)

FULL DISPR shows filter's pass capability at 3 frequencies.

Triple exposure photo

FREQUENCY is reset to desired 448.4MHz.

When DISPR is reduced to 10 MHz, two different coupling loop positions are found that provide about the same insertion loss but produce a difference in the shape of the curve.

Triple exposure photo

DISPR is reduced to 2 MHz/DIV. dB/DIV reset to 1dB.

VERT POS. used to re-reference cables.

It now becomes evident that the coupling loop positions also pull the frequency slightly.

Coupling loops are set for the sharper peak and the frequency is retuned to the center with the tuning rod.

APPLICATION NOTE

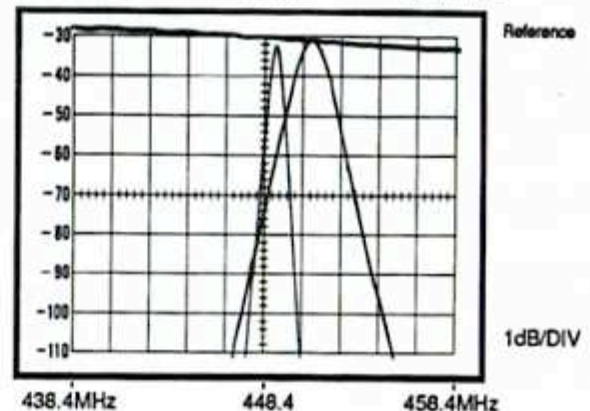
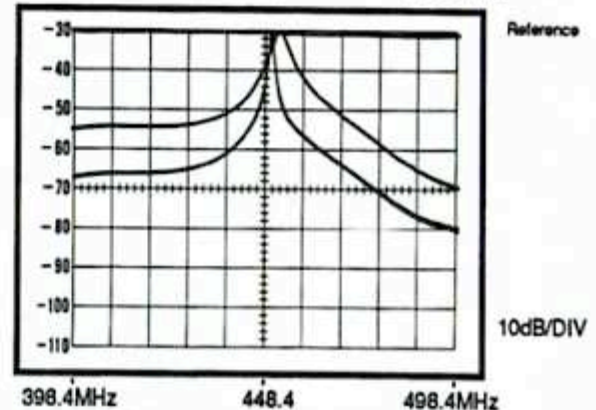
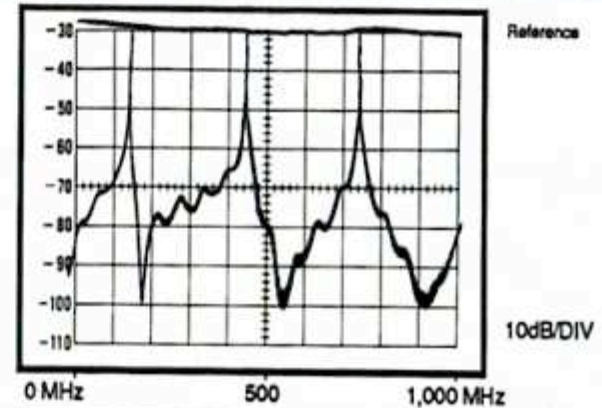

DETAILED SETUP

IFR FM/AM-1500

Measuring Center Frequency Insertion Loss and 3dB Points on Cavities

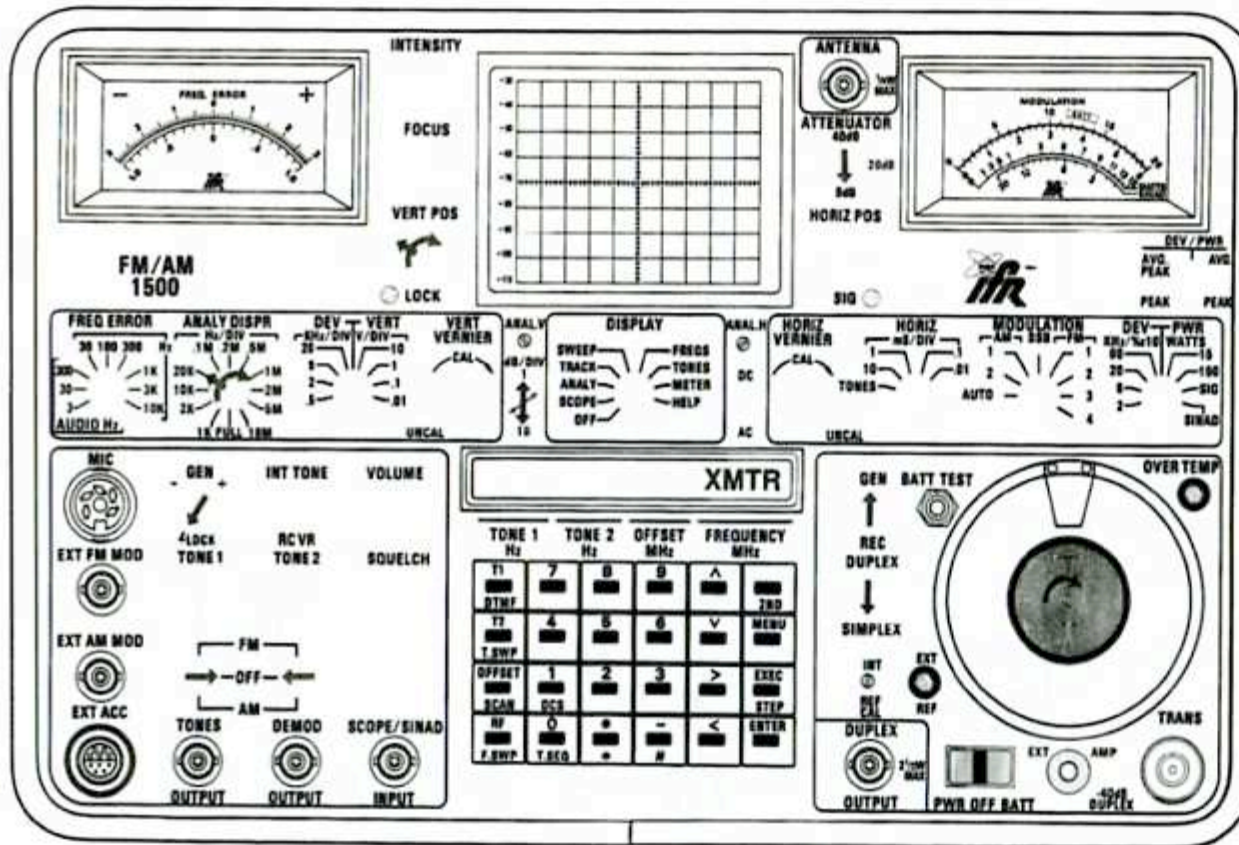

Be sure to calibrate out the combined slight variations of connecting cable losses, generator output and analyzer sensitivity when you change frequency if you're trying to split hairs on a measurement.

Test setup for swept frequency measurement

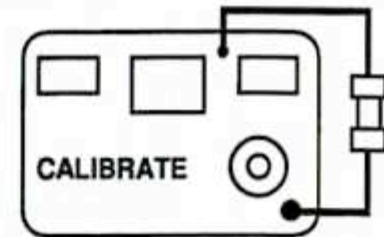

Calibrate out the test cable loss at each frequency. Connect your test cables together and reset the RF output control to bring the trace back to your reference point.

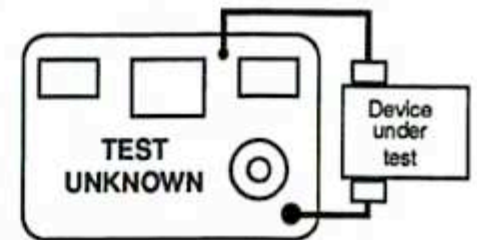

Transmitter Cavity Alignment

The tracking generator / spectrum analyzer function provides an instantaneous display of all the information needed to tune cavities and duplexers quickly and accurately.

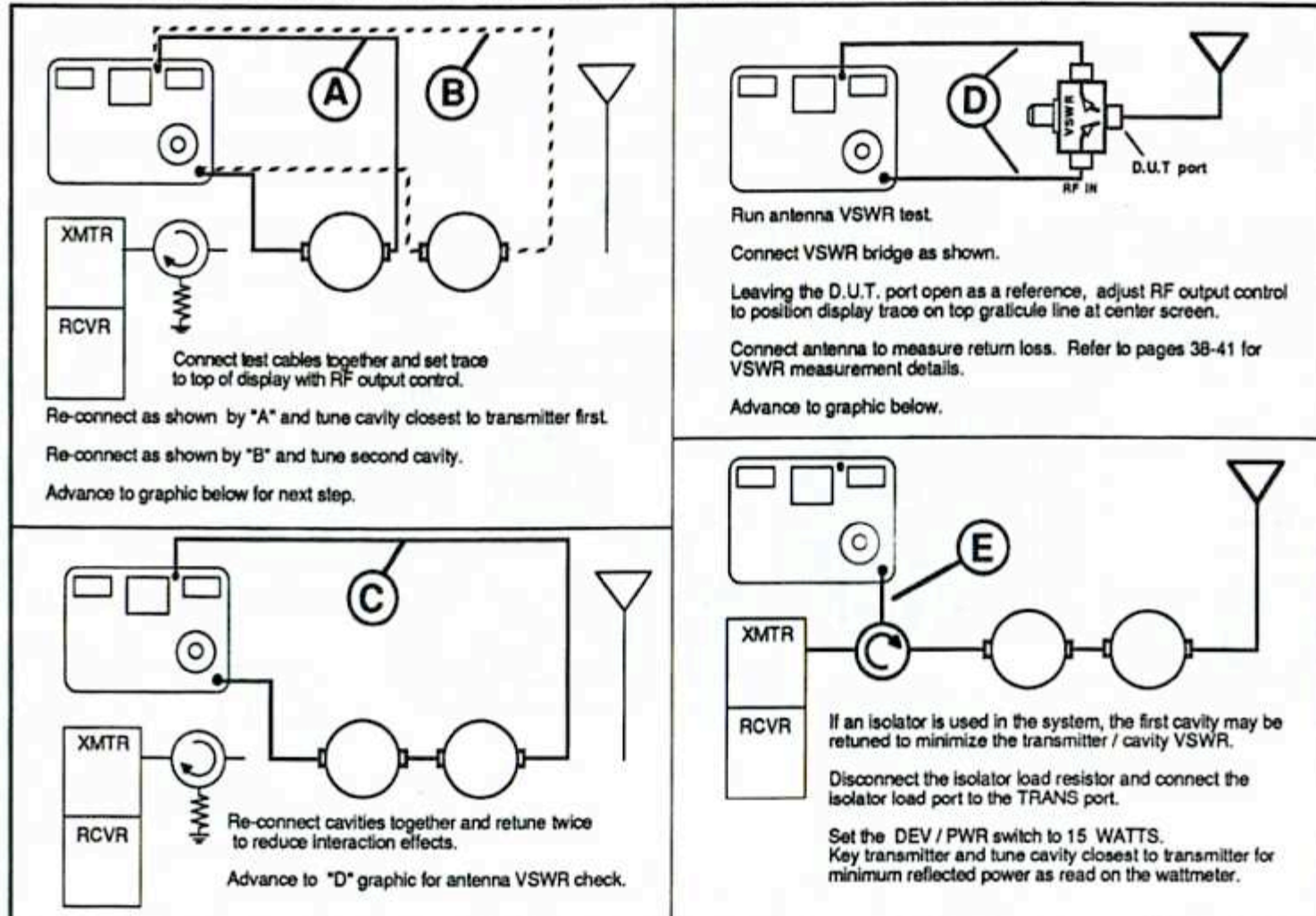

DETAILED SETUP

IFR FM/AM-1500

Transmitter Cavity Alignment

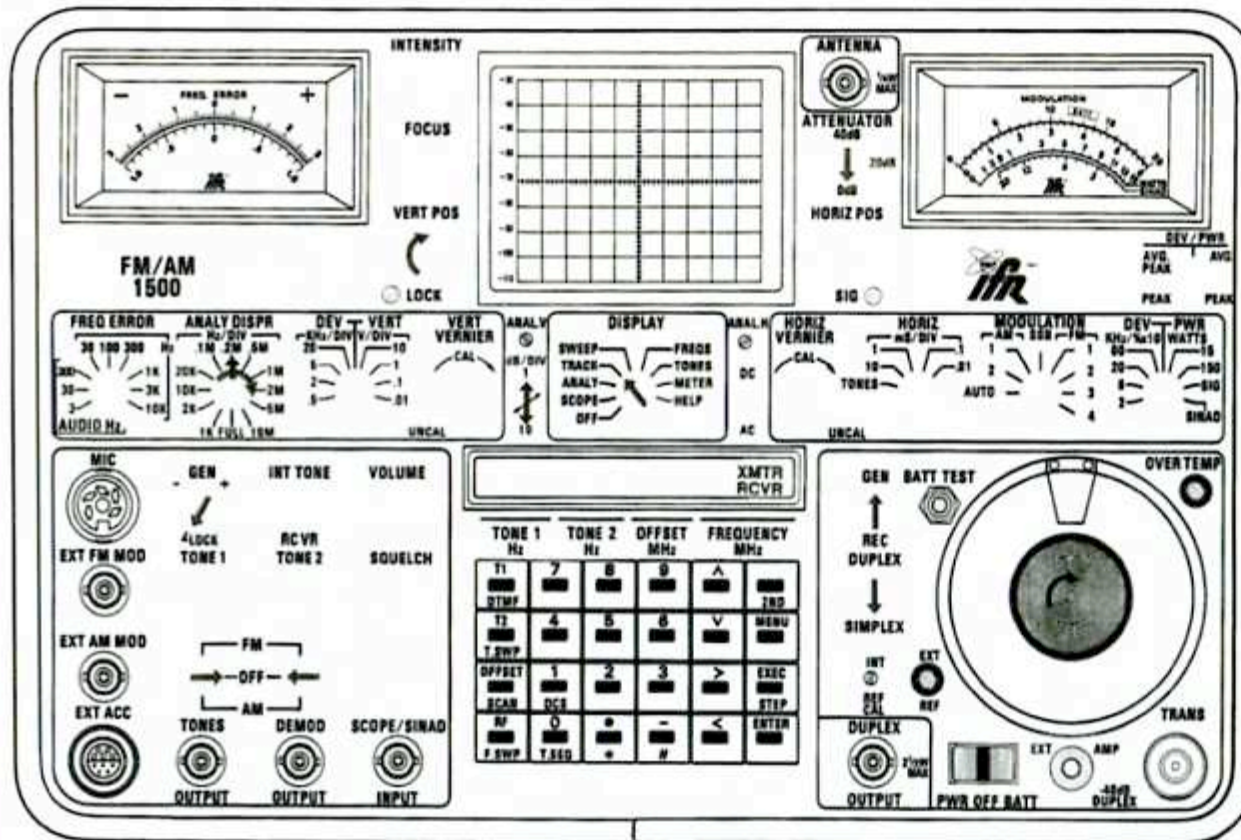

Connect as shown in graphic A on facing page.

With 1500's **FREQUENCY** set to the transmitter frequency, an obvious peak should be visible on the display.

FINE TUNING

If peak is close to center of screen, decrease **ANALYZER DISPERSION** to increase resolution so you can tune the cavity to center the peak exactly on frequency.

Increase the vertical resolution by switching to 1 dB/DIV and bringing trace back on screen with **VERTICAL POSITION** control.

For any loss measurements, you should always "calibrate out" the test cable loss at each frequency. Connect your test cables together and reset the RF output control to bring the trace back to your reference point.

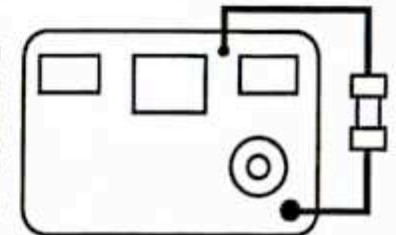

Bandpass / Band Reject Duplexer Alignment

Guidelines for cavity testing

Read and follow cavity maker's tuning recommendations.

Make an outline of the system components and frequencies and label all cables.

Use double shielded or semi-rigid coax.

Use **GOOD** connectors, avoid PL-259's / UHF connectors and inter-series adaptors. Keep connectors bright and clean.

Double peaking is usually caused by incorrect length connecting coax.

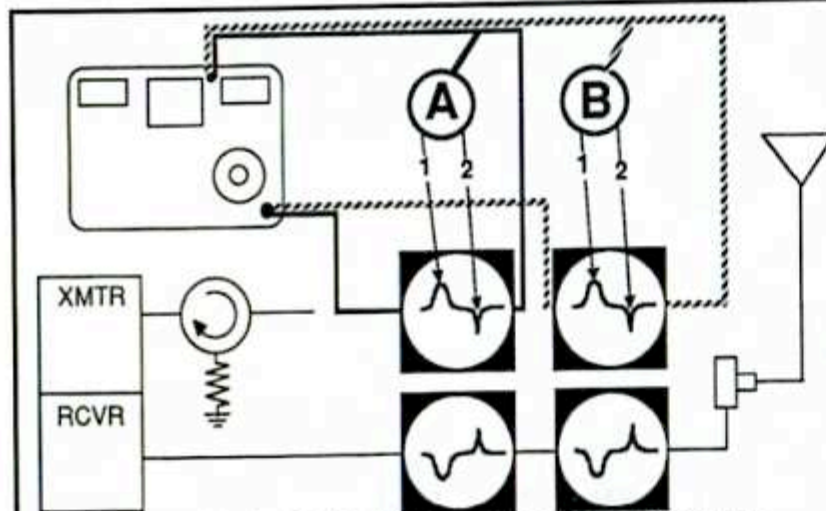

Align each cavity in the A1- A2- B1- B2 sequence shown. Go through the tuning sequence at least twice to minimize interaction effects. Advance to top right graphic for next step

APPLICATION NOTE

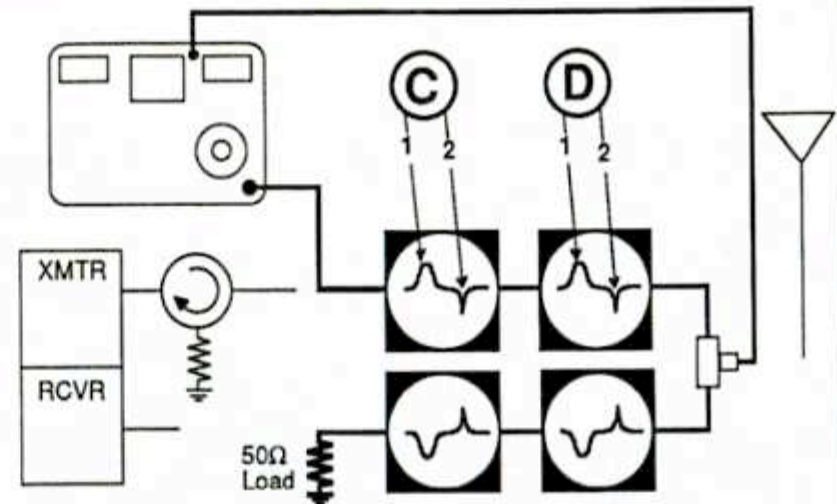

Connect to the duplexed system as shown. Load receiver output. Retune in the C1- C2 - C3 - C4 sequence shown at least twice. Advance to graphic below for receiver cavity tuning.

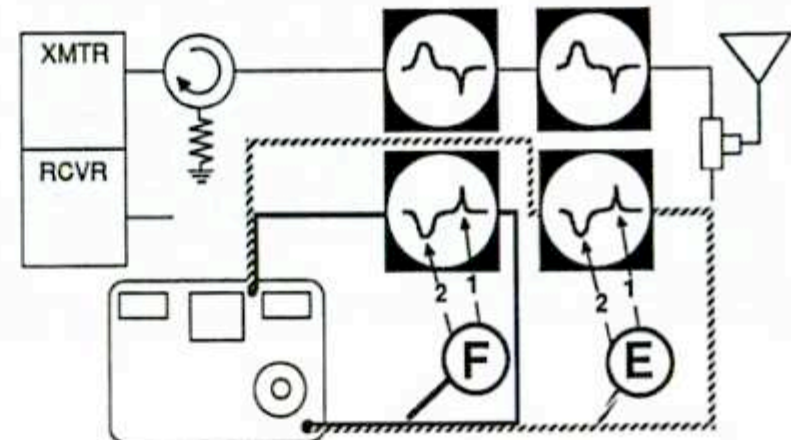

Tune receiver cavities in the E1 - E2 - F1 - F2 sequence shown (twice). Re-connect the duplexer system and run a desense test. (see page 50-51)

DETAILED SETUP

IFR FM/AM-1500

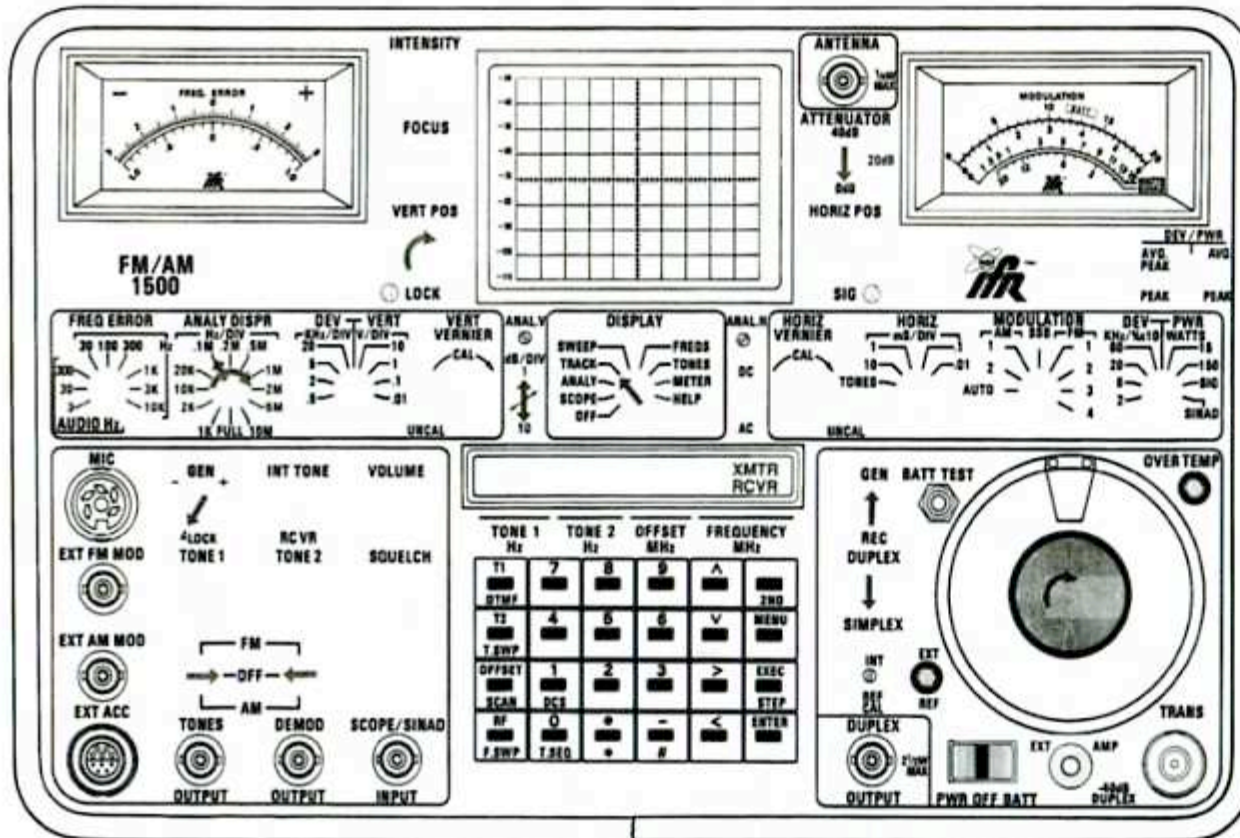

Bandpass / Band Reject Duplexer Alignment

By using the RF SCAN function, you only need program the transmitter and receiver frequencies once. When you run the RF SCAN program and stop the scan, a single keystroke will toggle the 1500 from the transmitter to the receiver frequency.

Switch the DISPLAY to FREQS. Call up the RF SCAN MENU by keying MENU, and the ^ key until RF SCAN MENU appears.

Enter the menu by ENTER, >. Key in the transmitter frequency. Example: 454.4, ENTER.

Advance to ITEM 02 by keying ^. A > will get you into the FREQ field. Key in the receiver frequency. Example: 459.4, ENTER.

Now that you have the two frequencies programmed in, switch the DISPLAY back to TRACK.

Run the RF SCAN program by EXEC, 2ND, SCAN, 1, - (THRU), 2, • (LOOP). ENTER will start the scan which will alternate between the two center frequencies continuously.

Stop the scan by keying 2ND, STEP. Now you can step from transmit to receive with a single ^ keystroke.

For any loss measurements, you should always "calibrate out" the test cable loss at each test frequency. Connect your test cables together and reset the RF output control to bring the trace back to your reference point.

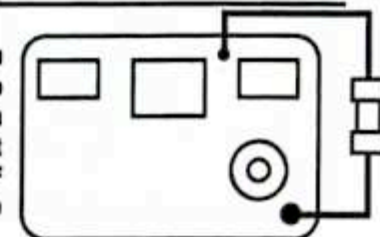

Measuring receiver desense in a duplexed system

Duplexer tuning is not complete until a receiver desense test has been completed.

There are several possibilities that can contribute to desensitization when the transmitter is keyed.

- Routing the transmitter coax too close to the receiver.
- Cable lacking sufficient shielding, use double shielded coax.
- Inadequate shielding between the transmitter and receiver sections within the radio.
- Poor connections at any point in the system can also cause desense.

APPLICATION NOTE

TEST PROCEDURE

Connect as shown below with the 50Ω load and run SINAD test. (see pages 10-11 for SINAD testing)

Record the RF level required to produce 12dB SINAD sensitivity.

Key transmitter. The amount that you need to increase the RF level to get back to 12dB SINAD is the desense figure due to the transmitter sideband noise.

EXAMPLE

50Ω: 12dB SINAD, Transmitter unkeyed	= -85 dBm
50Ω: 12dB SINAD, Transmitter keyed	= -80 dBm
Receiver desense due to sideband noise	= 5 dB

Connect the antenna and re-run the SINAD test with the transmitter keyed to determine combined system desense caused by Tx sideband noise and the antenna.

EXAMPLE

50Ω: 12dB SINAD, Transmitter unkeyed	= -85 dBm
Ant: 12dB SINAD, Transmitter keyed	= -72 dBm
Total system receiver degradation	= 13 dB

Thus if the basic receiver sensitivity was -115 dBm or .4 μv.
 subtract system degradation 13 dB
 Effective sensitivity is -102 dBm or 1.8 μv.

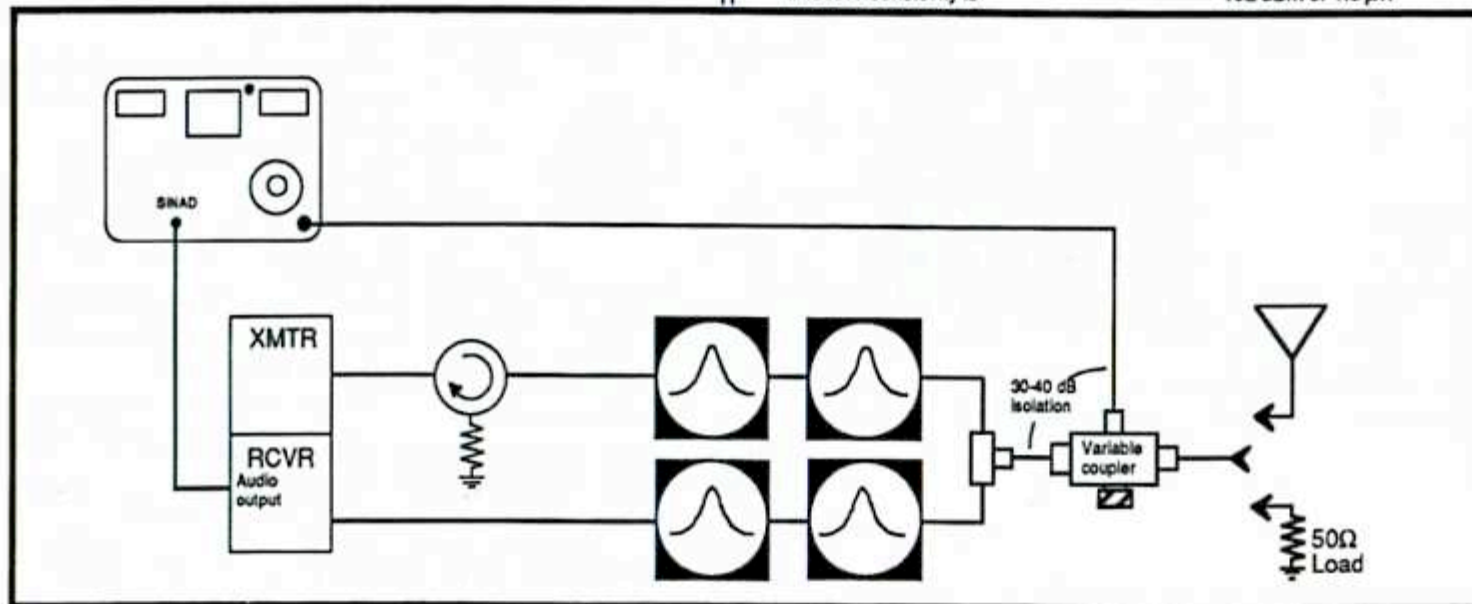

DETAILED SETUP

IFR FM/AM-1500

Measuring receiver desense
in a duplexed system

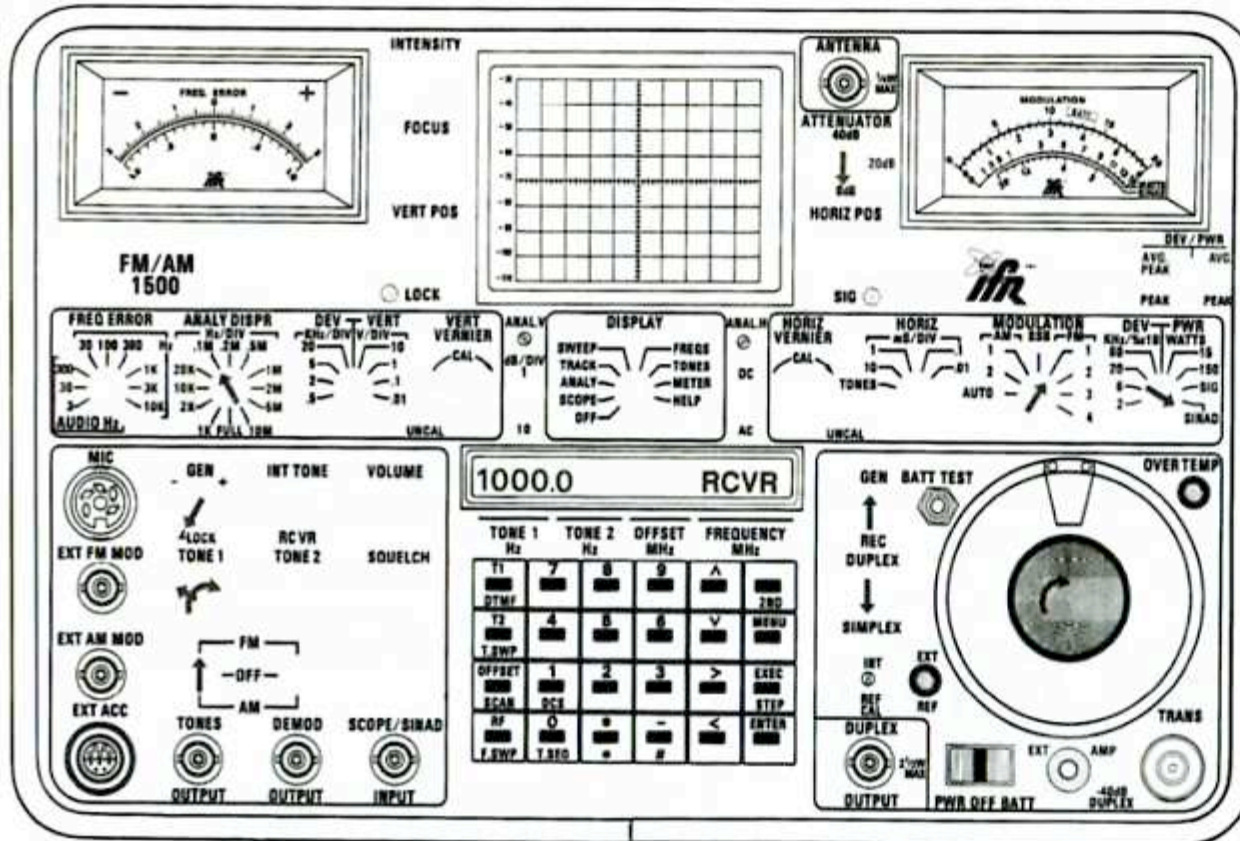

Measuring receiver isolation at Tx & Rx frequencies

Isolation, expressed in dB, is very important in the operation and maintenance of duplexed systems. Adequate isolation must be assured to prevent receiver degradation due to transmitter sideband noise.

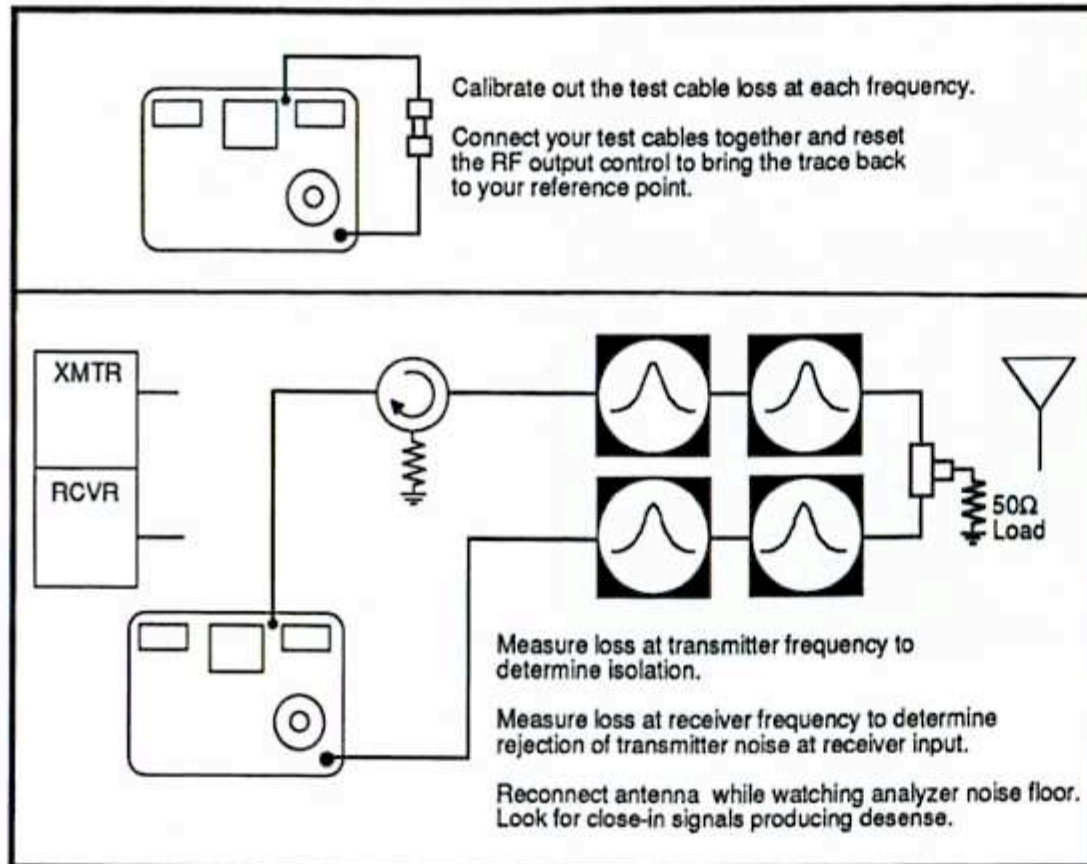

APPLICATION NOTE

TEST PROCEDURE

Connect as shown below. Set controls as shown on facing page.

Calibrate your cables by connecting them together and setting the trace to the top graticule line on the display.

Note the RF output dial setting, it should be close to -30 dBm.

Re-connect as shown in the bottom graphic.

Increase the RF output to 0 dBm and read the analyzer display at center screen (Tx freq.) for isolation.

Add the increase in RF output (≈ -30 dBm) to the dBm reading on screen to determine total isolation.

Change FREQUENCY to the receiver frequency.

Measuring attenuation at the receiver frequency will determine the isolation from transmitter noise at the receiver frequency.

Switch DISPLAY to ANALY.

While watching the noise floor near the receiver frequency, replace the 50Ω load with the antenna. Watch for on-channel or close-in desense indicated by an increase in the noise floor.

Key any transmitters nearby that are suspected intermod producers.

Re-connect transmitter and key both the suspect and this transmitter, looking for desense.

DETAILED SETUP

IFR FM/AM-1500

Measuring receiver isolation
at Tx & Rx frequencies

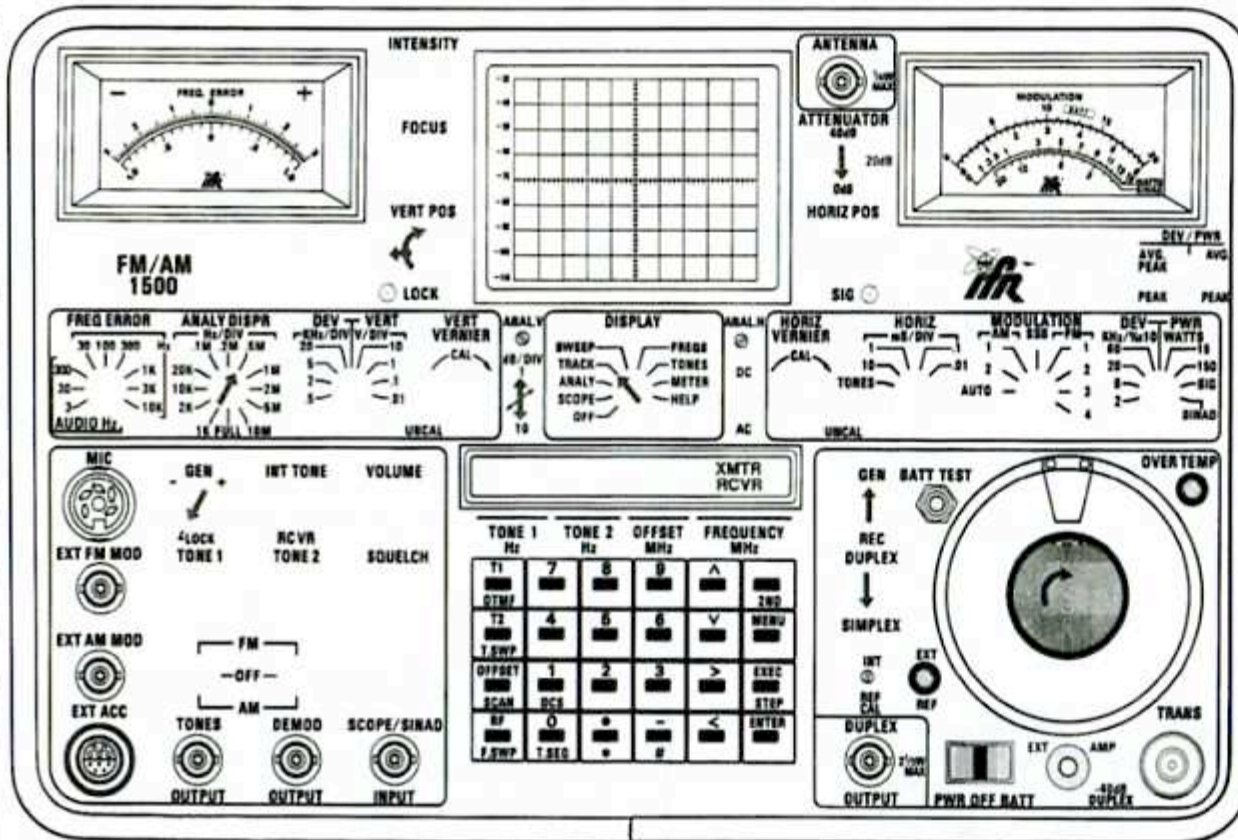

APPLICATION NOTE

Measuring Tx noise suppression at Rx frequency

Incoming inspection of new equipment is a good investment. No matter the stature, size or reputation of the manufacturer, bad radios *do* get into the field.

By measuring and recording the important performance parameters in a maintenance log *before* you install the equipment, you can establish a reference point that will be very helpful in future servicing.

TEST PROCEDURE

Perform receiver SINAD test. (see pages 10-11)

Record SINAD sensitivity.

Connect signal generator output (TRANS) to cavity or isolator nearest transmitter.

Raise RF output to re-achieve 12 dB SINAD. The difference is the transmitter noise suppression capability of the duplexer system.

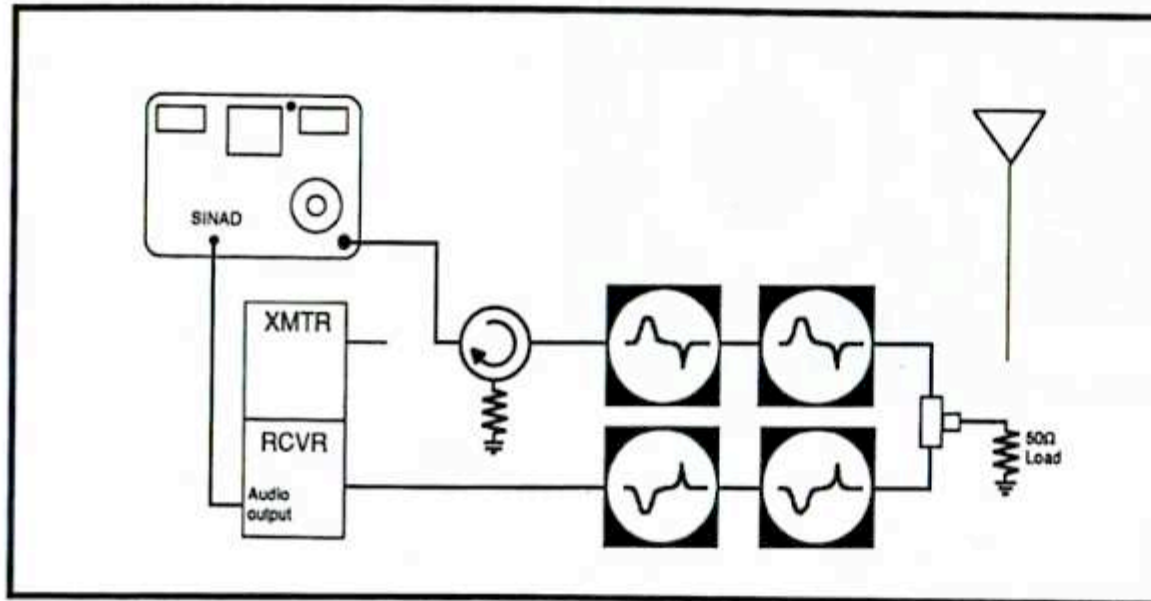

EXAMPLE

12 dB SINAD of receiver -112 dBm

12 dB SINAD through
duplexer assembly -10 dBm

Transmitter noise
suppression -92 dB

DETAILED SETUP

IFR FM/AM-1500

Measuring Tx noise suppression
at Rx frequency

